

S P A N I S H  
BASIC COURSE  
WORKBOOK

Module 4  
Lessons 19 - 24

September 1975

DEFENSE LANGUAGE INSTITUTE

## PREFACE

This Workbook is designed to be a self-study self-evaluation device and is to be used with a correlated set of cassette tapes, which contain the stimuli for the Listening Comprehension component and the Narrative Vocabulary Practice. The Preface of the Student Text contains general information relative to the Spanish (LA) Basic Course as a whole and the way this Workbook fits into the total scheme.

The Key to all exercises contained herein is found at the back portion of the Workbook. Students are encouraged to do all exercises the first time through without reference to the Key. Developing this habit of making honest attempts at understanding or "guessing," when not sure, will pay long range dividends.

Even though activities have been specified for each exercise, the student will soon be aware of the variety of things that can be done with each stimulus, whether it be recorded or printed. A newsbroadcast, for example, might be played repeatedly, almost as background noise, while the student merely absorbs the melody and flow of the language--picking out bits and pieces of meaning here and there. Once familiar with the content, students may wish to try a bit of "simultaneous" translation. In order to grasp the basic message, a good practice is to always keep in mind the questions: Who was involved? What happened? When? Why? Oral and printed stimuli may be gisted, summarized or even rewritten. Throughout this course, the instructor will provide additional activity suggestions for many of the exercises of this Workbook but self initiative is encouraged.

## TABLE OF CONTENTS

### STUDENT'S WORKBOOK

	<u>Page</u>
LESSON 19	1
Frame 1	3
Frame 2	11
Frame 3	15
Narrative	17
Review Exercises	21
Vocabulary Practice	23
LESSON 20	25
Frame 1	27
Frame 2	29
Frame 3	35
Narrative	41
Review Exercises	46
Vocabulary Practice	48
LESSON 21	49
Frame 1	51
Frame 2	55
Frame 3	59
Narrative	63
Review Exercises	67
Vocabulary Practice	70
LESSON 22	71
Frame 1	73
Frame 2	77
Frame 3	81
Narrative A	87
Narrative B	91
Review Exercise	93
Vocabulary Practice	94
LESSON 23	95
Frame 1	97
Frame 2	101
Frame 3	105
Narrative	108
Review Exercises	111
Vocabulary Practice	114



LISTENING COMPREHENSION EXERCISE A

Write complete Spanish responses to each of the following questions. There may be more than one answer for each.

Example: You will hear: ¿Cuál es su nombre?

You will write: Mi nombre es... or Me llamo...

1. \_\_\_\_\_
2. \_\_\_\_\_
3. \_\_\_\_\_
4. \_\_\_\_\_
5. \_\_\_\_\_
6. \_\_\_\_\_
7. \_\_\_\_\_
8. \_\_\_\_\_
9. \_\_\_\_\_
10. \_\_\_\_\_

LISTENING COMPREHENSION EXERCISE B

Replay the questions from the previous exercise and transcribe them.

1. \_\_\_\_\_
2. \_\_\_\_\_
3. \_\_\_\_\_
4. \_\_\_\_\_
5. \_\_\_\_\_
6. \_\_\_\_\_
7. \_\_\_\_\_
8. \_\_\_\_\_
9. \_\_\_\_\_
10. \_\_\_\_\_

LISTENING COMPREHENSION EXERCISE C

Write an English translation for each of the following Spanish sentences.

1. \_\_\_\_\_  
\_\_\_\_\_.
2. \_\_\_\_\_  
\_\_\_\_\_.
3. \_\_\_\_\_  
\_\_\_\_\_.
4. \_\_\_\_\_  
\_\_\_\_\_.
5. \_\_\_\_\_  
\_\_\_\_\_.
6. \_\_\_\_\_  
\_\_\_\_\_.
7. \_\_\_\_\_  
\_\_\_\_\_.
8. \_\_\_\_\_  
\_\_\_\_\_.
9. \_\_\_\_\_  
\_\_\_\_\_.
10. \_\_\_\_\_  
\_\_\_\_\_.

## LISTENING COMPREHENSION EXERCISE D

Listen to the following conversations, then circle the letters of the choices that make true statements about each.

- A. 1. When is his uncle coming?
- (a) This morning.
  - (b) Tomorrow.
  - (c) Today.
2. Which uncle is coming?
- (a) Manuel.
  - (b) Jose.
  - (c) Antonio.
- B. 1. The military maneuvers
- (a) finished Wednesday.
  - (b) began Wednesday.
  - (c) are going to start Wednesday.
2. The second battalion
- (a) was sent by the general.
  - (b) did not participate.
  - (c) is going to participate.
- C. 1. Which report was received?
- (a) The reveille report.
  - (b) The retreat report.
  - (c) Neither one.
2. Which report was found?
- (a) The reveille report.
  - (b) The retreat report.
  - (c) Neither of the two.



- D. 1. It was mentioned in the conversation that
- (a) there is a paratrooper roster.
  - (b) the paratroopers are ready.
  - (c) some paratroopers are involved in a revolution.
2. There is a report
- (a) about the paratroopers.
  - (b) on the top of the desk.
  - (c) in the file cabinet.

MODULE 4

FRAME 1

LESSON 19

LISTENING COMPREHENSION EXERCISE E

Listen to each of the following Spanish sentences. Transcribe each sentence as you hear it in the space provided, and circle the letter of the best translation.

1. \_\_\_\_\_

- (a) We don't want to talk about the revolution.
- (b) We don't have to talk about the revolution.
- (c) We shouldn't talk about the revolution.

2. \_\_\_\_\_

- (a) You didn't put the copies of the receipts with the originals.
- (b) You don't have to put the copies of the receipts with the originals.
- (c) You mustn't put the copies of the receipts with the originals.

3. \_\_\_\_\_

- (a) Why didn't you bring the telephone operator?
- (b) Why didn't you bring the telephones here?
- (c) Why didn't you bring the phone book?

4. \_\_\_\_\_
- (a) In which wars did you participate?
  - (b) In which war did your unit participate?
  - (c) In which wars did their units participate?
5. \_\_\_\_\_
- (a) The argument was about the Second War.
  - (b) The discussion took place during the Second War.
  - (c) The speech was on the Second War.
6. \_\_\_\_\_
- (a) I paid the government what I owed them.
  - (b) The government paid him what they had to.
  - (c) You should pay the government what you owe them.
7. \_\_\_\_\_
- (a) Jose did not read the information on the heater.
  - (b) Jose wrote down the information on the calender.
  - (c) Jose noticed the information on the daily bulletin.
8. \_\_\_\_\_
- (a) We still don't know what caused the attack.
  - (b) We still don't know who started the tank.
  - (c) We still don't know who began the attack.
9. \_\_\_\_\_
- (a) In what operation didn't you participate?
  - (b) Who didn't participate in the operation?
  - (c) In what operations did you participate?
10. \_\_\_\_\_
- (a) Bring me another newspaper, please.
  - (b) Bring me another stack of papers, please.
  - (c) Bring me another pad, please.

LISTENING COMPREHENSION EXERCISE F

Translate the following Spanish sentences.

1. \_\_\_\_\_
2. \_\_\_\_\_
3. \_\_\_\_\_
4. \_\_\_\_\_
5. \_\_\_\_\_
6. \_\_\_\_\_
7. \_\_\_\_\_
8. \_\_\_\_\_
9. \_\_\_\_\_
10. \_\_\_\_\_

END OF FRAME 1



## LISTENING COMPREHENSION EXERCISE A

Listen to each of the following Spanish questions or statements. Circle the letter of the best response to each.

1. (a) Podemos cruzar inmediatamente.  
(b) Necesitamos más tiempo.  
(c) Ahora vamos a tener más agua.  
(d) Es imposible destruir la represa.
2. (a) Entonces, tenemos que arreglarla.  
(b) Estaba en la Marina de Guerra.  
(c) Entonces, no la destruyeron.  
(d) Envíela en el próximo informe.
3. (a) Sí, señor, porque Ud. se lo pidió.  
(b) Sí, señor, porque necesitaba más tiempo.  
(c) Sí, señor, porque Ud. no firmó el recibo.  
(d) Sí, señor, porque ella nunca llega temprano.
4. (a) Debemos recibir al Estado Mayor.  
(b) Un avión se estrelló en el aeropuerto.  
(c) El general quiere el parte de diana.  
(d) Si nos sorprenden, va a haber muchos muertos.
5. (a) Por eso había muchos submarinos.  
(b) Sin embargo, no fue buen comandante.  
(c) No sabía que él era sargento.  
(d) Solamente van a enviar un pelotón.
6. (a) ¿Cuántos perecieron en el accidente?  
(b) ¿De dónde venía el ferrocarril?  
(c) ¿Está descompuesto su teléfono?  
(d) ¿Por qué estaba en la torre?
7. (a) Nos debe \$40.00, más o menos.  
(b) Le debe mucho a su padre.  
(c) Debe de ser muy honrado.  
(d) Solamente tuvo que pagar \$40.00.

8. (a) Debe de estar en otro informe.  
(b) No creyó que era necesario.  
(c) La ropa no es muy cara.  
(d) No había nadie en ese lugar.
9. (a) La traje ayer por la tarde.  
(b) El original no estaba en la carpeta.  
(c) Uds. no me comprendieron.  
(d) Sin embargo, perdió el original.
10. Entonces,
- (a) ¿quién fue?  
(b) ¿por qué lo copió?  
(c) ¿quién lo recibió?  
(d) ¿por qué lo creyó?

MODULE 4

FRAME 2

LESSON 19

LISTENING COMPREHENSION EXERCISE B

Listen to the following news broadcasts in Spanish. Circle the letters of the choices that make true statements about each. Guess at the meaning of any new words.

- I. From the information contained in this news broadcast, it appears that
1. (a) the ministers fled for their lives.  
(b) the President left La Moneda followed by his Cabinet.  
(c) the President prepared for battle.  
(d) all the palace guards were killed in the attack.
2. (a) the attack took place in the afternoon.  
(b) there were survivors after the attack.  
(c) the attack was observed by the many bystanders.  
(d) some civilians left La Moneda in the afternoon.
- II. 1. (a) The Revolutionary Government's support is in the capital.  
(b) "Tres Palacios" is the name of the capital.  
(c) "Tres Palacios" is 20 miles to the north of the capital.  
(d) There are three palaces in the capital.

2.
    - (a) Tanks attacked the capital.
    - (b) The Revolutionary Government controls the capital.
    - (c) Airplanes destroyed many tanks.
    - (d) The tanks received air support.
  
  3.
    - (a) The Revolutionary Government has the Air Force support.
    - (b) Intensive fighting continues to take place in the capital.
    - (c) The Revolutionary Government controlled zones north of the capital.
    - (d) Airplanes and helicopters strafed the capital.
- III. 1.
  - (a) The Corps of Engineers had recently finished the bridge.
  - (b) The Corps of Engineers had partially completed the bridge.
  - (c) The government doesn't know who is responsible for the explosion.
  - (d) The government blames the Corps of Engineers for the incident.
2.
    - (a) Some people in the government are irresponsible.
    - (b) The explosion killed a group of people.
    - (c) Subversive forces are active in the country.
    - (d) An engineer lost an eye in the explosion.
  
  3.
    - (a) The Corps of Engineers tested a new bomb on an old bridge.
    - (b) There are three subversive groups in the country.
    - (c) The Corps of Engineers is not responsible for the explosion.
    - (d) Three engineers have produced a new, powerful bomb.
- IV. 1. As a consequence,
- (a) the U.S. has cut off all aid.
  - (b) Peru has threatened to break off relations.
  - (c) the U.S. has sent its fleet home.
  - (d) Peru has extended its territorial limits.

LISTENING COMPREHENSION EXERCISE C

Translate the following sentences into English.

1. \_\_\_\_\_
2. \_\_\_\_\_
3. \_\_\_\_\_
4. \_\_\_\_\_
5. \_\_\_\_\_
6. \_\_\_\_\_
7. \_\_\_\_\_
8. \_\_\_\_\_
9. \_\_\_\_\_
10. \_\_\_\_\_

END OF FRAME 2



## LISTENING COMPREHENSION EXERCISE A

Listen to each of the following number phrases. Write only the numbers in Arabic numerals. Do not write any other words.

1. \_\_\_\_\_ 2. \_\_\_\_\_ 3. \_\_\_\_\_ 4. \_\_\_\_\_  
5. \_\_\_\_\_ 6. \_\_\_\_\_ 7. \_\_\_\_\_ 8. \_\_\_\_\_  
9. \_\_\_\_\_ 10. \_\_\_\_\_

## LISTENING COMPREHENSION EXERCISE B

Replay the first five number sentences from Exercise A. First transcribe them, and then translate your transcription.

1. \_\_\_\_\_  
\_\_\_\_\_  
\_\_\_\_\_
2. \_\_\_\_\_  
\_\_\_\_\_  
\_\_\_\_\_
3. \_\_\_\_\_  
\_\_\_\_\_  
\_\_\_\_\_
4. \_\_\_\_\_  
\_\_\_\_\_  
\_\_\_\_\_

5.

---

---

END OF FRAME 3

NOTE: Do not do the Vocabulary Practice until you have completed the Narrative and the Review Exercises.

DENUNCIA<sup>1</sup> EL DIARIO<sup>2</sup> "LIBERACIÓN"<sup>3</sup>

NUEVAS VIOLACIONES<sup>4</sup> DEL RÉGIMEN<sup>5</sup>

REGLA, 20 de mayo (PM). La agencia de prensa "Liberación" denunció hoy nuevas violaciones gubernamentales<sup>6</sup> en las provincias<sup>7</sup> centrales de San Julián y Victoria, y en la sureña<sup>8</sup> de Trinidad.

Según un boletín<sup>9</sup> captado<sup>10</sup> el día 13 de mayo, cinco batallones de los Regimientos<sup>11</sup> 42, 44, 45 y 53 de Rosario, apoyados<sup>12</sup> por aviación y artillería,<sup>13</sup> atacaron<sup>14</sup> zonas<sup>15</sup> bajo el control del Ejército Revolucionario<sup>16</sup> en dichas<sup>17</sup> provincias.

Agrega la agencia de noticias que, durante los combates,<sup>18</sup> las tropas<sup>19</sup> revolucionarias causaron<sup>20</sup> más de<sup>21</sup> 80 bajas<sup>22</sup> al gobierno, y capturaron<sup>23</sup> 31 armas<sup>24</sup> de diversos<sup>25</sup> calibres.<sup>26</sup>

Señaló<sup>27</sup> a continuación<sup>28</sup> la muerte<sup>29</sup> de 26 civiles en la provincia de Trinidad, en el curso de las operaciones de expansión<sup>30</sup> de la dictadura en zonas liberadas.<sup>31</sup>

- 1 \_\_\_\_\_
- 2 (daily) news-  
paper
- 3 \_\_\_\_\_
- 4 \_\_\_\_\_
- 5 \_\_\_\_\_
- 6 \_\_\_\_\_
- 7 \_\_\_\_\_
- 8 southern
- 9 \_\_\_\_\_
- 10 received
- 11 \_\_\_\_\_
- 12\* supported
- 13\* \_\_\_\_\_
- 14 \_\_\_\_\_
- 15\* \_\_\_\_\_
- 16 \_\_\_\_\_
- 17 said
- 18\* \_\_\_\_\_
- 19\* \_\_\_\_\_
- 20 \_\_\_\_\_
- 21 more than
- 22\* casualties
- 23 \_\_\_\_\_
- 24 weapons; arms
- 25 various
- 26 \_\_\_\_\_
- 27\* it pointed out
- 28 next
- 29\* death
- 30 \_\_\_\_\_
- 31 \_\_\_\_\_

"Liberación" acusó<sup>32</sup> al teniente coronel Jacinto Madariaga, jefe del sector<sup>33</sup> militar de Granada, del asesinato<sup>34</sup> de los civiles cuando éstos se resistieron<sup>35</sup> a ser trasladados<sup>36</sup> hacia "aldeas<sup>37</sup> estratégicas."<sup>38</sup>

Dijo que, después de muertos, los civiles fueron despojados<sup>39</sup> de sus pertenencias<sup>40</sup> personales<sup>41</sup> por soldados del régimen.

Poco después de la partida<sup>42</sup> de la tropa, la artillería del gobierno bombardeó<sup>43</sup> la zona y causó heridas a siete personas.

Por su parte, la delegación<sup>44</sup> del Ejército Revolucionario ante<sup>45</sup> la Comisión<sup>46</sup> Internacional de Control y Vigilancia<sup>47</sup> exigió<sup>48</sup> hoy la libertad de cinco personas acusadas<sup>49</sup> por la dictadura de llevar a cabo<sup>50</sup> actividades<sup>51</sup> subversivas."<sup>52</sup>

- 32 \_\_\_\_\_
- 33 \_\_\_\_\_
- 34 murder; assassination
- 35 refused to; resisted
- 36\* transferred
- 37 villages
- 38 \_\_\_\_\_
- 39 stripped
- 40 belongings
- 41 \_\_\_\_\_
  
- 42 departure
  
- 43 \_\_\_\_\_
  
- 44 \_\_\_\_\_
- 45 to; before
- 46 \_\_\_\_\_
  
- 47 supervision
- 48 demanded
- 49 \_\_\_\_\_
- 50\* carry out
- 51 \_\_\_\_\_
- 52 \_\_\_\_\_

\*These words will be part of your active vocabulary.

Some of the numbered underlined words in the Narrative have English cognates (similar forms and meaning in English). These have not been translated for you but numbered spaces have been provided in the margin. Go back to the Narrative and guess at the meaning of each of the cognates. Write your guess in the appropriate space in the margin, then check your answers with the Key.

Write Spanish answers to the following questions based on the Narrative.

This exercise is intended to develop your reading comprehension and writing skills. Therefore, it is to your advantage to answer the questions on the Narrative as explicitly as possible. Don't limit your answers to short responses.

1. ¿Dónde tuvieron lugar las violaciones gubernamentales?

---

---

2. ¿Cuáles fueron los regimientos que participaron en el ataque?

---

---

3. ¿Cuántas bajas tuvo el gobierno?

---

---

4. ¿Por qué fueron asesinados los civiles?

---

---

5. ¿Cuándo fueron despojados de sus pertenencias los civiles?

---

---

6. ¿Qué armas capturaron las fuerzas revolucionarias?

---

---

7. ¿Qué exigió el Ejército Revolucionario?

---

---

---

8. ¿Quién es el teniente coronel Jacinto Madariaga?

---

---

---

9. ¿Cuáles zonas atacó la artillería?

---

---

---

10. ¿Qué señaló la agencia de prensa "Liberación" en Trinidad?

---

---

---

Translate the words and phrases in parentheses into Spanish.

1. ¿\_\_\_\_\_ son las horas de oficina?  
(Which)
2. \_\_\_\_\_ está sobre mi escritorio.  
(The reveille report)
3. Nosotros \_\_\_\_\_ esos documentos.  
(mustn't sign)
4. \_\_\_\_\_ están allí, son mis hermanas.  
(Those who)
5. La División 82 participó en \_\_\_\_\_.  
(that attack)
6. La secretaria \_\_\_\_\_ el original.  
(didn't include)
7. No pude ver \_\_\_\_\_ porque no encontré  
la llave. (the file)
8. Es necesario enviarle este sobre al \_\_\_\_\_.  
(admiral)
9. \_\_\_\_\_ es eléctrica.  
(This typewriter)
10. Creo que va a ser fácil \_\_\_\_\_ la operación.  
(to carry out)

Translate the following sentences into Spanish.

1. What is your schedule?

---

2. She believed what I told her.

---

3. You (pl.) did not include in your report a list of the zones you visited.

---

4. He is in charge of Company A.

---

5. Don't ask me why I include that man among my enemies.

---

6. He says he didn't hear the explosion.

---

7. The engineer who built the bridge wants more money.

---

8. They already read the report about the new government budget.

---

9. The guerrillas destroyed the dam last night.

---

10. Before, it used to be necessary to be here at 7:30 A.M., but now it is not necessary to arrive at that time.

---



Listen to the following words from the Narrative for this lesson. Each will be given twice; once in isolation and once in a complete sentence. Translate the complete sentence into English.

1.

---

---

2.

---

---

3.

---

---

4.

---

---

5.

---

---

6.

---

---

7.

---

---

8.

---

---

9.

---

---

10.

---

---



LESSON 20

STUDENT'S WORKBOOK

MODULE 4

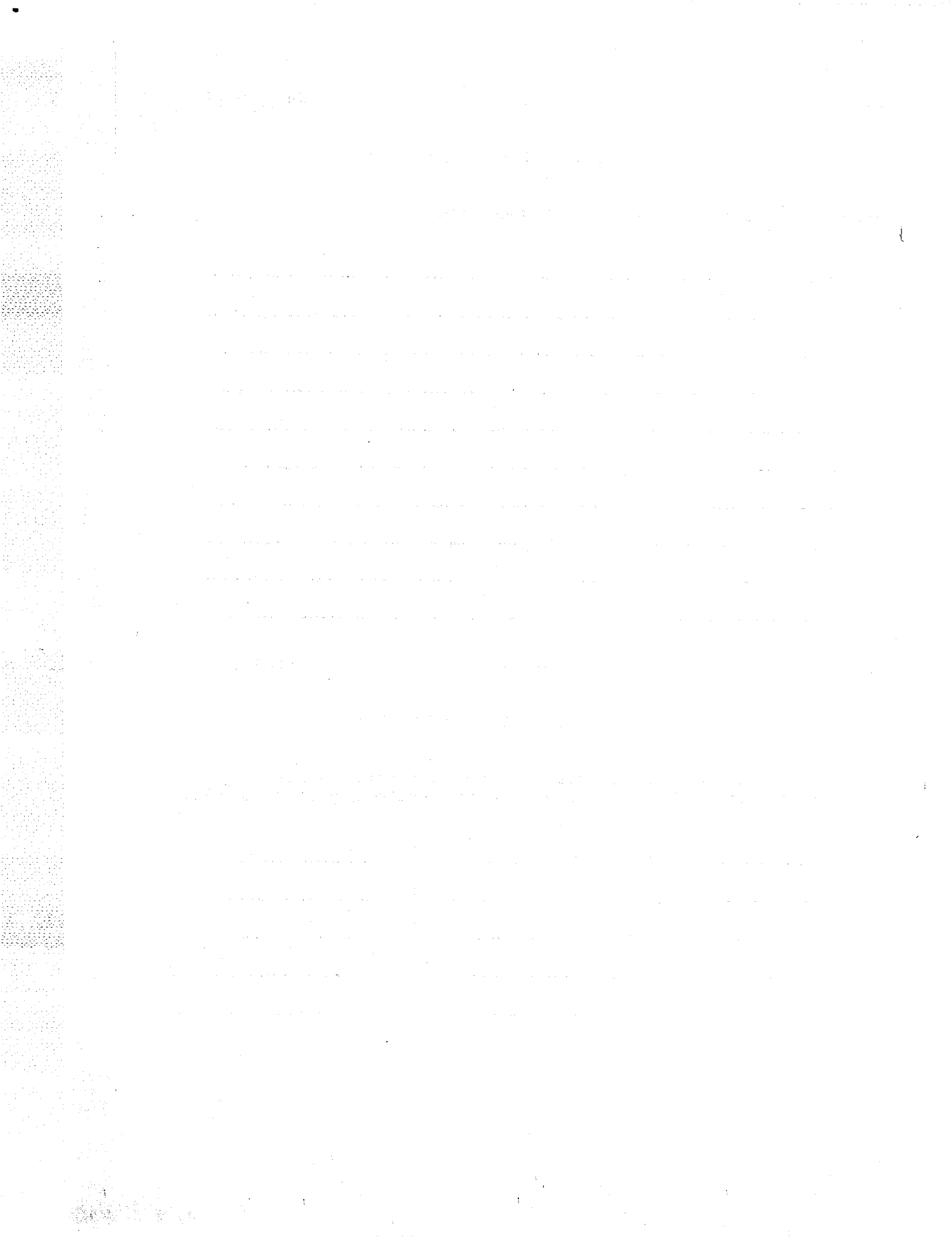

## LISTENING COMPREHENSION EXERCISE A

Translate the following Spanish sentences.

1. \_\_\_\_\_
2. \_\_\_\_\_
3. \_\_\_\_\_
4. \_\_\_\_\_
5. \_\_\_\_\_
6. \_\_\_\_\_
7. \_\_\_\_\_
8. \_\_\_\_\_
9. \_\_\_\_\_
10. \_\_\_\_\_

## LISTENING COMPREHENSION EXERCISE B

Listen to each of the following number phrases. Write only the numbers in Arabic numerals. Do not write any other words.

- |           |           |           |
|-----------|-----------|-----------|
| 1. _____  | 2. _____  | 3. _____  |
| 4. _____  | 5. _____  | 6. _____  |
| 7. _____  | 8. _____  | 9. _____  |
| 10. _____ | 11. _____ | 12. _____ |
| 13. _____ | 14. _____ | 15. _____ |

## LISTENING COMPREHENSION EXERCISE C

Listen to each of the following Spanish sentences. First, transcribe each sentence in the space provided; and second, write an English translation for each.

1. \_\_\_\_\_  
\_\_\_\_\_
2. \_\_\_\_\_  
\_\_\_\_\_
3. \_\_\_\_\_  
\_\_\_\_\_
4. \_\_\_\_\_  
\_\_\_\_\_
5. \_\_\_\_\_  
\_\_\_\_\_
6. \_\_\_\_\_  
\_\_\_\_\_
7. \_\_\_\_\_  
\_\_\_\_\_
8. \_\_\_\_\_  
\_\_\_\_\_
9. \_\_\_\_\_  
\_\_\_\_\_
10. \_\_\_\_\_  
\_\_\_\_\_

END OF FRAME 1

## LISTENING COMPREHENSION EXERCISE A

Listen to the following passages and circle the letter of the choice which makes a true statement about each.

1. (a) How he wishes he never had a car!  
(b) He felt the mechanic did a poor job.  
(c) So far no one has been able to fix his car.  
(d) He thought the mechanic charged him too much.
2. (a) The traffic was terrible on her way to work.  
(b) She was not able to buy any gasoline.  
(c) There was not much gasoline at the station.  
(d) They had run out of gasoline.
3. (a) He didn't know it was so hard to change a tire.  
(b) He didn't think it was so easy to change a flat tire.  
(c) It's hard to teach a woman to change a flat tire.  
(d) His wife's car doesn't have a spare tire.
4. (a) She enjoys working on her car at home.  
(b) The mechanic didn't have what she needed.  
(c) Everyone knows some basic facts about cars.  
(d) The mechanic must have thought she was crazy.
5. (a) A dead battery is always a real problem!  
(b) A problem of this kind is going to cost a lot of money.  
(c) It is easy to recharge your car's battery.  
(d) In most cases you have to buy a new one.
6. (a) A flashlight is a handy item to carry in the car.  
(b) The law requires it to be carried inside the car.  
(c) It can be a problem to carry a flashlight in the car.  
(d) We need it to light the interior of the car.

LISTENING COMPREHENSION EXERCISE B

Listen to the following radio commercial. First, transcribe everything in the space provided; second, circle all of the words in each that you do not recognize; and third, use a dictionary to translate each of the unfamiliar words into English. Write the translations at the bottom of the page.

---

---

---

---

---

---

---

---

---

---



## LISTENING COMPREHENSION EXERCISE C

Listen to the following Spanish sentences and write the number of each sentence beside its English equivalent.

1. a. ( ) It costs you a lot of money.
2. b. ( ) I gave him an old spare tire.
3. c. ( ) How much did he charge us?
4. d. ( ) He needs a jack to change the tire.
5. e. ( ) Did he fix it?  
f. ( ) I ran out of gas.
  
6. g. ( ) He doesn't guarantee his work.
7. h. ( ) We have to use several tools.
8. i. ( ) It's necessary to tune the motor.
9. j. ( ) It's necessary to clean the carburetor.
10. k. ( ) I am going to buy a flashlight.  
l. ( ) I recharged a dead battery.

## LISTENING COMPREHENSION EXERCISE D

Listen to each of the following sentences and write short answers in English to the questions in your workbook.

1. How much does my little brother eat?

---

2. What is necessary to have to make those repairs?

---

3. What are pinzas and who uses them?

---

4. Why is it necessary to know auto mechanics?

---

5. What's wrong with my used car?

---

6. What happens when your car is well tuned?

---

7. What did I have repaired and what did it cost?

---

LISTENING COMPREHENSION EXERCISE E

Listen to each of the following Spanish sentences. First, transcribe each sentence in the space provided; and second, write an English translation for each.

- 1. \_\_\_\_\_  
\_\_\_\_\_
- 2. \_\_\_\_\_  
\_\_\_\_\_
- 3. \_\_\_\_\_  
\_\_\_\_\_
- 4. \_\_\_\_\_  
\_\_\_\_\_
- 5. \_\_\_\_\_  
\_\_\_\_\_
- 6. \_\_\_\_\_  
\_\_\_\_\_
- 7. \_\_\_\_\_  
\_\_\_\_\_
- 8. \_\_\_\_\_  
\_\_\_\_\_
- 9. \_\_\_\_\_  
\_\_\_\_\_

## LISTENING COMPREHENSION EXERCISE F

Listen to each of the following number phrases. Write only the numbers in Arabic numerals. Do not write any other words.

1. \_\_\_\_\_

9. \_\_\_\_\_

2. \_\_\_\_\_

10. \_\_\_\_\_

3. \_\_\_\_\_

11. \_\_\_\_\_

4. \_\_\_\_\_

12. \_\_\_\_\_

5. \_\_\_\_\_

13. \_\_\_\_\_

6. \_\_\_\_\_

14. \_\_\_\_\_

7. \_\_\_\_\_

15. \_\_\_\_\_

8. \_\_\_\_\_

END OF FRAME 2

## LISTENING COMPREHENSION EXERCISE A

Listen to the following sentences and circle the letter of the best English translation for each.

1. (a) They are worried about their first test.  
(b) They worried about the first exam of the course.  
(c) The first exams made them worry a lot.  
(d) The first exam was not worth worrying about.
  
2. (a) The recently appointed ambassador arrived in the capital for talks with the President.  
(b) The new ambassador and the President arrived in the capital for talks.  
(c) The recently elected President and the Ambassador met in the capital.  
(d) The new ambassador recently arrived in the capital, where he met the President.
  
3. (a) If you don't pay for the motor, he's going to get very angry.  
(b) If he doesn't install the engine now, it's going to take him longer.  
(c) If you don't turn off the engine, it's going to overheat.  
(d) If he doesn't tune up the motor, it's going to run very slowly.
  
4. (a) Don't worry about me! I'm going to lie down for a few minutes before leaving.  
(b) Don't worry on my account. I'm just taking a short nap before going out.  
(c) Don't worry about me! I just want to rest a little before going out.  
(d) Don't be so preoccupied! I'm only resting a bit before going out with you.

5.
  - (a) I don't know exactly which country I'm going to after finishing the Spanish course.
  - (b) I don't know exactly what I'll be doing when the Spanish course ends.
  - (c) Who knows where I'll be sent after finishing the Spanish course.
  - (d) I don't know why they are sending me to that country when the Spanish course ends.
  
6.
  - (a) He keeps on forgetting it and has to learn it again.
  - (b) He always gets paid for it and has to fix it again.
  - (c) It continually fades on him and he has to turn it on again.
  - (d) It constantly goes out on him and he has to light it again.

## LISTENING COMPREHENSION EXERCISE B

Listen to each of the following Spanish sentences. First, transcribe each sentence in the space provided; and second, write an English translation for each.

1. \_\_\_\_\_  
\_\_\_\_\_
2. \_\_\_\_\_  
\_\_\_\_\_
3. \_\_\_\_\_  
\_\_\_\_\_
4. \_\_\_\_\_  
\_\_\_\_\_
5. \_\_\_\_\_  
\_\_\_\_\_
6. \_\_\_\_\_  
\_\_\_\_\_

END OF FRAME 3

NOTE: Do not do the Vocabulary Practice until you have completed the Narrative and Review Exercises.

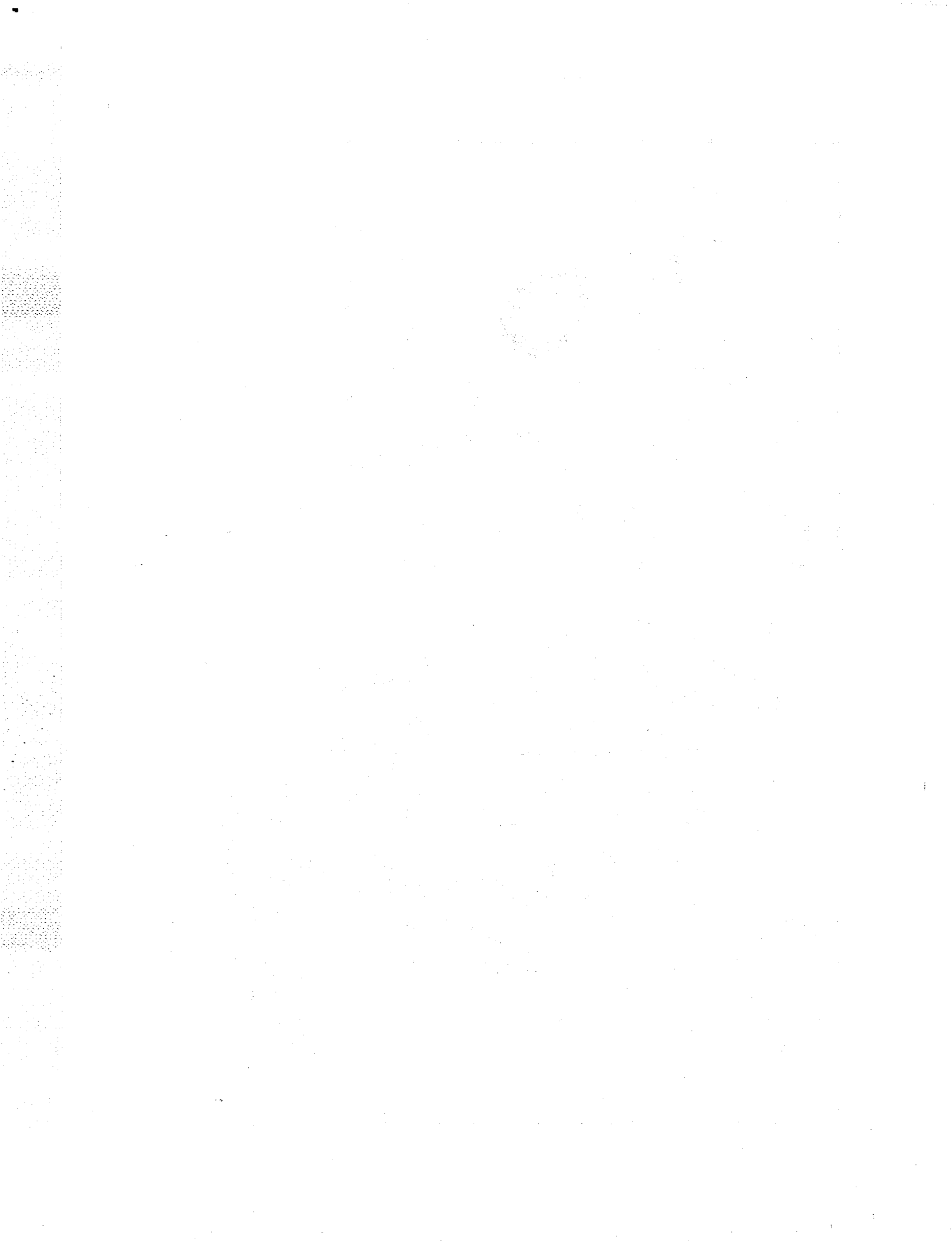



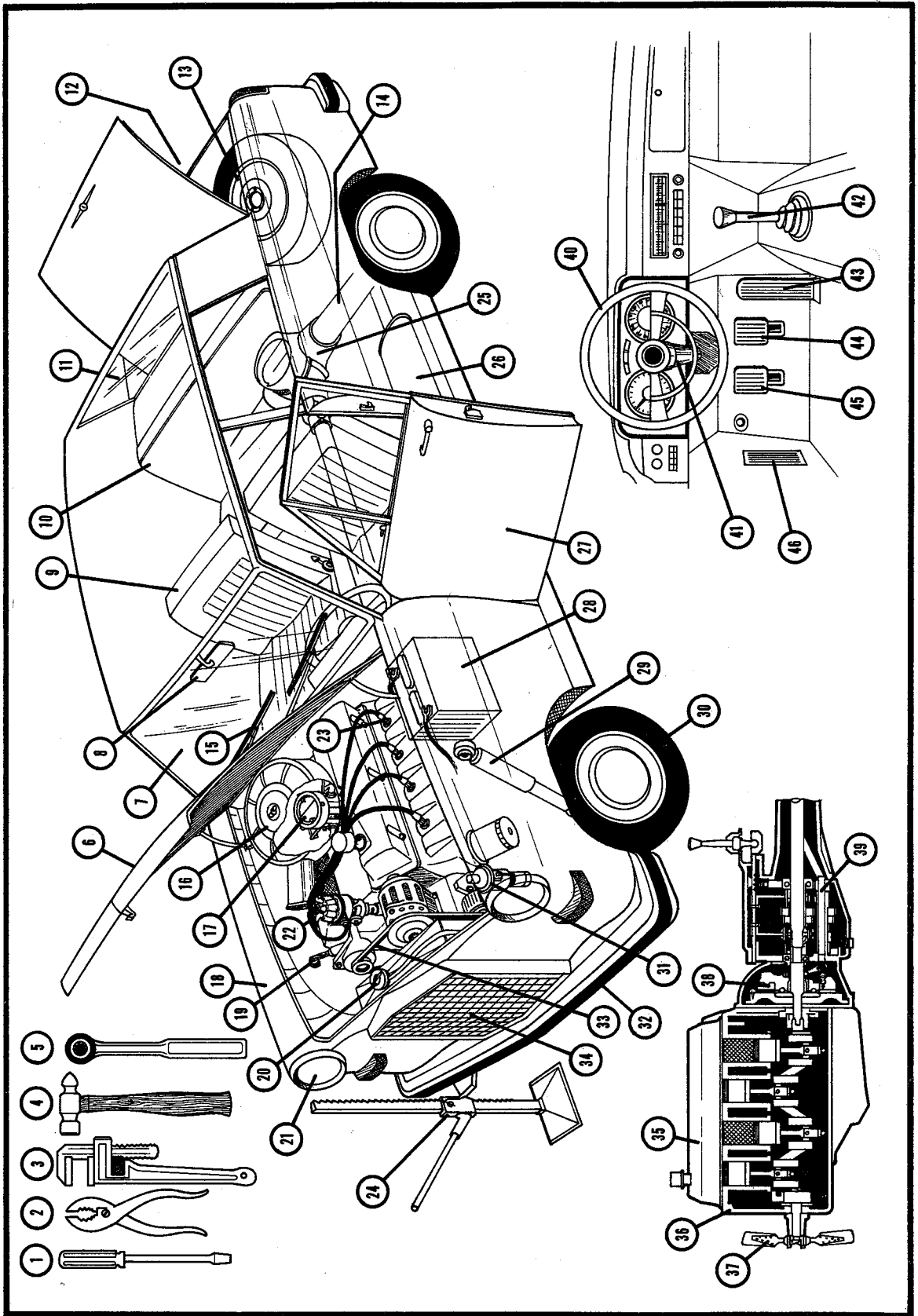

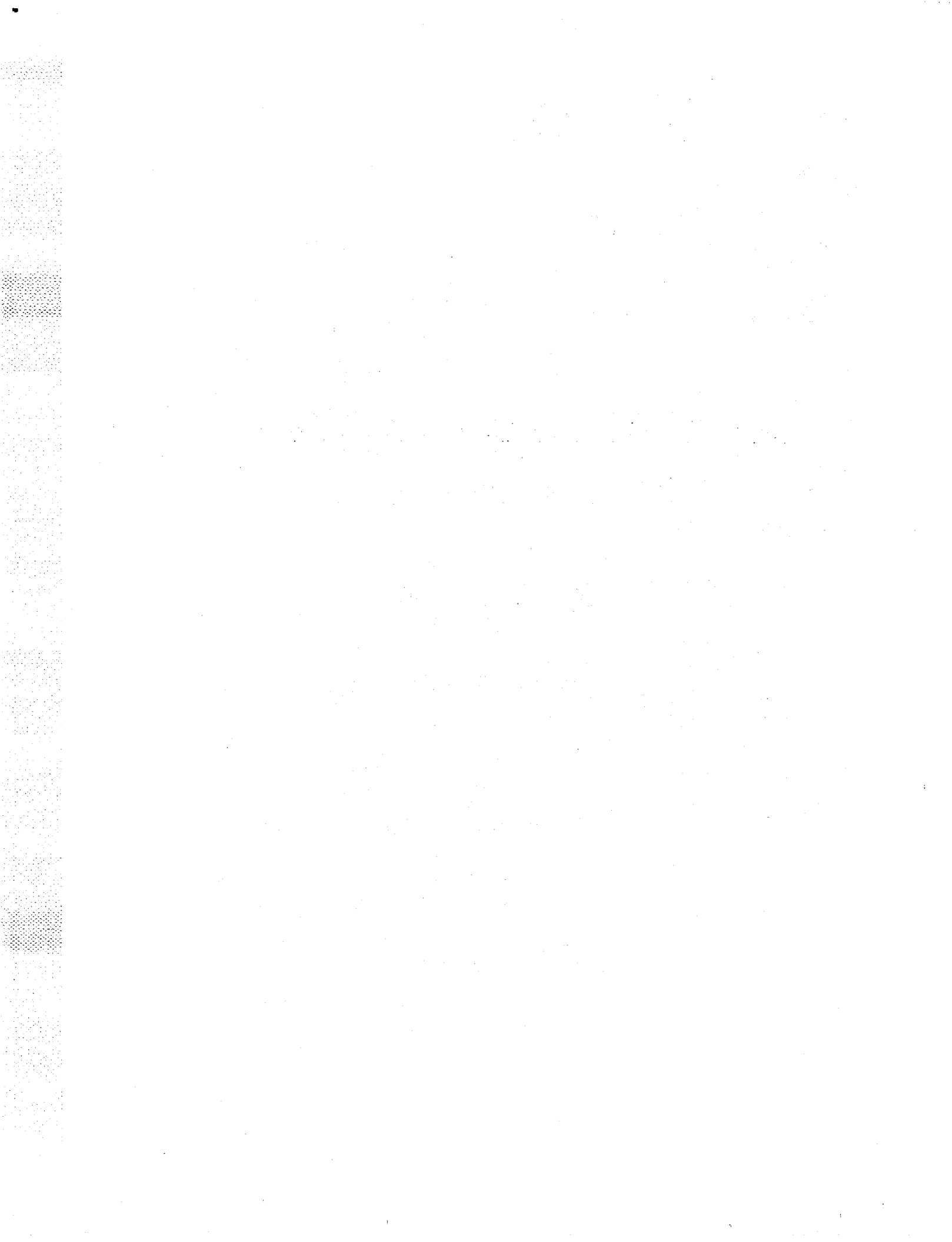

(No prose narrative is provided; see Exercise B for the Narrative.)

- |   |   |
|---|---|
| 1. el destornillador<br>- screwdriver                 | 16. el <u>filtro de aire</u><br>- air filter                                  |
| 2. las pinzas<br>- pliers                             | 17. el carburador<br>- carburetor   |
| 3. la <u>llave*</u><br>- wrench                       | 18. el <u>guardafangos</u><br>- fender  |
| 4. el martillo<br>- hammer                            | 19. la <u>varilla para medir</u><br>el <u>nivel del aceite</u><br>- dip stick |
| 5. la <u>llave de cubo</u><br>- socket wrench         | 20. la <u>tapa del radiador</u><br>- radiator cap                             |
| 6. el <u>capó</u><br>- hood                           | 21. el <u>faro</u><br>- headlight   |
| *7. el <u>parabrisas*</u><br>- windshield             | 22. el <u>distribuidor</u><br>- distributor                                   |
| 8. el <u>espejo* retrovisor*</u><br>- rearview mirror | 23. la bujía<br>- spark plug  |
| 9. el <u>asiento* delantero*</u><br>- front seat      | 24. el gato<br>- jack   |
| 10. el <u>asiento trasero*</u><br>- rear seat         | 25. el <u>diferencial</u><br>- differential                                   |
| 11. la <u>ventanilla trasera</u><br>- rear window     | *26. el <u>silenciador*</u><br>- muffler                                      |
| 12. el <u>baúl*</u><br>- trunk                        | 27. la puerta<br>- door   |
| 13. la llanta de repuesto<br>- spare tire             | 28. el acumulador; la batería<br>- battery                                    |
| 14. el <u>eje trasero</u><br>- rear axle              | *29. el <u>amortiguador*</u><br>- shock absorber                              |
| 15. el <u>limpiaparabrisas*</u><br>- windshield wiper |   |

30. la llanta  
- tire
31. la bomba de gasolina\*  
- fuel pump
32. el parachoques; la defensa  
- bumper
33. la correa\* del ventilador\*  
- fan belt
34. el radiador  
- radiator
35. la tapa de válvulas  
- valve cover
36. el bloque de cilindros  
- cylinder block
37. el ventilador  
- fan
38. el embrague; el cloche  
- clutch
39. la transmisión  
- transmission
40. el volante\*  
- steering wheel
41. la columna de dirección  
- steering column
42. la palanca de cambios\*  
- stick shift
43. el acelerador  
- accelerator
44. el pedal del freno\*  
- brake; brake pedal\*
45. el pedal del embrague  
- clutch pedal
46. el respiradero  
- vent

Circle the letter of the choice which best completes each statement.

1. Para ver de noche, es necesario prender \_\_\_\_\_.

- (a) el ventilador
- (b) el embrague
- (c) los faros del auto
- (d) el asiento delantero

2. El chofer del carro se sienta en \_\_\_\_\_.

- (a) el eje trasero
- (b) el asiento delantero
- (c) el baúl
- (d) el asiento trasero

3. \_\_\_\_\_ limpian el parabrisas.

- (a) Las llantas
- (b) Los parachoques
- (c) Las pinzas
- (d) Los limpiaparabrisas

4. \_\_\_\_\_ paran el auto.

- (a) Los pedales
- (b) Los frenos
- (c) Los amortiguadores
- (d) Los faros

5. En \_\_\_\_\_ uno puede ver lo que está  
detrás del auto.

- (a) el espejo retrovisor
- (b) el baúl
- (c) el radiador
- (d) el filtro

6. En un auto de cambios, es necesario usar \_\_\_\_\_  
para pasar de primera a segunda.
- (a) el acelerador
  - (b) el diferencial
  - (c) el silenciador
  - (d) el embrague
7. Para ir más rápidamente, uno usa \_\_\_\_\_.
- (a) el acelerador
  - (b) la transmisión
  - (c) la varilla
  - (d) el guardafangos
8. Es imposible prender el motor sin un buen \_\_\_\_\_.
- (a) freno
  - (b) silenciador
  - (c) gato
  - (d) acumulador



Translate the following sentences into Spanish:

1. What is necessary to do in order to change a flat tire?  
\_\_\_\_\_  
\_\_\_\_\_
2. It is important to use the rear view mirror when you drive your car.  
\_\_\_\_\_  
\_\_\_\_\_
3. The driver of a manual shift car has to use three pedals in order to drive it.  
\_\_\_\_\_  
\_\_\_\_\_
4. The windshield wipers let us see the road when it rains.  
\_\_\_\_\_  
\_\_\_\_\_
5. In order to work well, the carburetor needs gasoline and completely clean air.  
\_\_\_\_\_  
\_\_\_\_\_
6. When we travel by car we put our suitcases in the trunk.  
\_\_\_\_\_  
\_\_\_\_\_
7. Two of the most important tools for car repairs are the screwdriver and the wrench.  
\_\_\_\_\_  
\_\_\_\_\_



Write the number of each Spanish sentence by its English equivalent.

1. Mis amigos se sentaron en el asiento trasero.
  2. El chofer de un vehículo tiene que sentarse detrás del volante.
  3. Los autos que no tienen silenciador hacen mucho ruido.
  4. El mecánico cambió las bujías con una llave especial.
  5. Necesitamos un gato para subir el auto.
  6. El motor se calentó porque el ventilador no tenía correa.
  7. No podíamos ver nada porque el limpiapara-brisas no funcionaba.
- a.  Gasoline passes into the carburetor through the fuel pump.
  - b.  My friends sat in the front seat.
  - c.  My friends sat in the back seat.
  - d.  The mechanic opened the trunk with a special key.
  - e.  The mechanic changed the sparkplugs with a special wrench.
  - f.  We need a jack in order to jack up the car.
  - g.  The driver of a vehicle has to sit behind the steering wheel.
  - h.  The engine overheated because the fan had no belt.
  - i.  Cars that do not have a muffler make a lot of noise.
  - j.  We couldn't see a thing because the windshield wipers weren't working.

Listen to the following words from the Narrative for this lesson. Each will be given twice: once in isolation and once in a complete sentence. Translate each of the complete sentences into English.

1. \_\_\_\_\_
2. \_\_\_\_\_
3. \_\_\_\_\_
4. \_\_\_\_\_
5. \_\_\_\_\_
6. \_\_\_\_\_
7. \_\_\_\_\_
8. \_\_\_\_\_
9. \_\_\_\_\_
10. \_\_\_\_\_
11. \_\_\_\_\_
12. \_\_\_\_\_

LESSON 21

STUDENT'S WORKBOOK

MODULE 4

10/10/10

10/10/10

10/10/10

### 10/10/10

10/10/10

10/10/10

10/10/10

10/10/10

10/10/10

10/10/10

10/10/10

10/10/10

## LISTENING COMPREHENSION EXERCISE A

Listen to the following short conversations. Circle the letter of the best English translation of the response in each.

1. (a) Yes, because it's time to go to work.  
(b) Yes, because it's time to leave work.  
(c) Yes, because it's lunch time.  
(d) Yes, it was time to leave him.
2. (a) I'm coming.  
(b) What happened?  
(c) What did he do?  
(d) What's wrong with him?
3. (a) There's a long way to go yet.  
(b) Because we missed a lot.  
(c) There is still a lot of rain.  
(d) Because we'll never arrive.
4. (a) With much gusto.  
(b) If you like.  
(c) With pleasure.  
(d) Why not?
5. (a) Maybe, but he has plenty, too.  
(b) Possibly, but you are older.  
(c) Maybe, but you have plenty of time, also.  
(d) Possibly, but you have been here longer.
6. (a) Five dollars is missing.  
(b) I'm missing five dollars.  
(c) I'd like five dollars.  
(d) He's missing five dollars.
7. (a) Yes, I'm going to buy one.  
(b) Yes, I'm going to buy some.  
(c) Yes, I'm going to buy tea.  
(d) Yes, I'm going to buy a car.

8. (a) He has to come.  
(b) He has to go.  
(c) You have to come.  
(d) You have to go.
9. (a) That's nice of you.  
(b) That's enough.  
(c) That's bad for you.  
(d) That's too much.
10. (a) Don't worry, we are almost there.  
(b) Don't worry, there is little missing.  
(c) Don't worry, he's not absent much.  
(d) Don't worry, we have a few.

MODULE 4

FRAME 1

LESSON 21

LISTENING COMPREHENSION EXERCISE B

Listen to each of the following Spanish sentences. First, transcribe each sentence; and second, write an English translation for each.

1. \_\_\_\_\_  
\_\_\_\_\_
2. \_\_\_\_\_  
\_\_\_\_\_
3. \_\_\_\_\_  
\_\_\_\_\_
4. \_\_\_\_\_  
\_\_\_\_\_
5. \_\_\_\_\_  
\_\_\_\_\_

6. \_\_\_\_\_  
\_\_\_\_\_
7. \_\_\_\_\_  
\_\_\_\_\_
8. \_\_\_\_\_  
\_\_\_\_\_

MODULE 4

FRAME 1

LESSON 21

LISTENING COMPREHENSION EXERCISE C

Listen to each of the following number phrases. Write only the numbers in Arabic numerals. Do not write any other words.

1. \_\_\_\_\_ 2. \_\_\_\_\_ 3. \_\_\_\_\_
4. \_\_\_\_\_ 5. \_\_\_\_\_ 6. \_\_\_\_\_
7. \_\_\_\_\_ 8. \_\_\_\_\_ 9. \_\_\_\_\_
10. \_\_\_\_\_

END OF FRAME 1





## LISTENING COMPREHENSION EXERCISE A

Listen to the following Spanish sentences. Circle the letter of the best English translation of each.

1. (a) You get better every day, Linda.  
(b) You get more like Linda each day.  
(c) You get prettier every day.  
(d) You get skinnier each day.
2. (a) What's that man arguing about?  
(b) What's that man worrying about?  
(c) What's that man scared about?  
(d) What's that man complaining about?
3. (a) You don't ever have change, Fernando.  
(b) You don't ever change, Fernando.  
(c) Don't ever change, Fernando.  
(d) Don't ever move, Fernando.
4. (a) Look at yourself, Luisito.  
(b) Get dressed, Luisito.  
(c) Go away, Luisito.  
(d) Watch out, Luisito.
5. (a) Come in, gentlemen.  
(b) He is in front, gentlemen.  
(c) Go straight ahead, gentlemen.  
(d) He's ahead, gentlemen.
6. (a) Exams get increasingly harder.  
(b) Examinations are becoming easier every time.  
(c) Difficult exams are given more than once.  
(d) Easier examinations are given only once.
7. (a) Linda is over there.  
(b) Linda is outside.  
(c) Linda is in there.  
(d) Linda is downtown.
8. (a) Why did the sergeant go to war?  
(b) Why did the sergeant put his cap on?  
(c) Why did the sergeant get fat?  
(d) Why did the sergeant get bored?

## LISTENING COMPREHENSION EXERCISE B

Listen to each of the following Spanish sentences. First, transcribe each sentence; and second, write an English translation for each.

1. \_\_\_\_\_  
\_\_\_\_\_
2. \_\_\_\_\_  
\_\_\_\_\_
3. \_\_\_\_\_  
\_\_\_\_\_
4. \_\_\_\_\_  
\_\_\_\_\_
5. \_\_\_\_\_  
\_\_\_\_\_
6. \_\_\_\_\_  
\_\_\_\_\_
7. \_\_\_\_\_  
\_\_\_\_\_
8. \_\_\_\_\_  
\_\_\_\_\_
9. \_\_\_\_\_  
\_\_\_\_\_
10. \_\_\_\_\_  
\_\_\_\_\_

## LISTENING COMPREHENSION EXERCISE C

Listen to the following Spanish sentences. Write the number of each sentence beside its English equivalent.

1. a. ( ) Come in, come in.
2. b. ( ) She's going to leave right away.
3. c. ( ) She's going to get dressed right away.
4. d. ( ) You're always so kind with everybody.
5. e. ( ) Where are you calling from, honey?  
f. ( ) He never gets nervous.
  
6. g. ( ) That's OK; don't worry.
7. h. ( ) Bring it over here.
8. i. ( ) He looks somewhat tired.
9. j. ( ) He put on a sailor cap.
10. k. ( ) He left a little tired.  
l. ( ) My room is in there.

END OF FRAME 2

MEMORANDUM FOR THE RECORD

On 10/10/50, the following information was received from the [redacted] regarding the [redacted] of [redacted] in [redacted] on [redacted].

[redacted] advised that [redacted] was [redacted] on [redacted] at [redacted] and [redacted] on [redacted] at [redacted].

[redacted] further advised that [redacted] was [redacted] on [redacted] at [redacted] and [redacted] on [redacted] at [redacted].

[redacted] advised that [redacted] was [redacted] on [redacted] at [redacted] and [redacted] on [redacted] at [redacted].

[redacted] advised that [redacted] was [redacted] on [redacted] at [redacted] and [redacted] on [redacted] at [redacted].

[redacted] advised that [redacted] was [redacted] on [redacted] at [redacted] and [redacted] on [redacted] at [redacted].

[redacted] advised that [redacted] was [redacted] on [redacted] at [redacted] and [redacted] on [redacted] at [redacted].

[redacted] advised that [redacted] was [redacted] on [redacted] at [redacted] and [redacted] on [redacted] at [redacted].

[redacted] advised that [redacted] was [redacted] on [redacted] at [redacted] and [redacted] on [redacted] at [redacted].

[redacted] advised that [redacted] was [redacted] on [redacted] at [redacted] and [redacted] on [redacted] at [redacted].

## LISTENING COMPREHENSION EXERCISE A

Listen to the following series of Spanish questions and statements. Circle the letter of the best response to each.

1. (a) Sí, hay que comer en el club.  
(b) Sí, porque va a ser muy importante.  
(c) No, yo no pude ir.  
(d) No, no había mucha gente.
  
2. (a) Sí, yo manejo.  
(b) No, yo no tengo tu licencia.  
(c) Sí, hay que llevarla.  
(d) No, hay mucho tráfico.
  
3. (a) Está bien, no importa.  
(b) Con mucho gusto.  
(c) No hay de qué.  
(d) El gusto es mío.
  
4. (a) Fuimos ayer.  
(b) Mucha tarea.  
(c) No hay de qué.  
(d) Por la mañana.
  
5. (a) Gracias, no sé bailar.  
(b) No me quiero parar.  
(c) Cómo no, con mucho gusto.  
(d) Perdóname, acá está.
  
6. (a) ¿Qué le pasó?  
(b) Perdóname.  
(c) ¿Quién falta?  
(d) Adelante.
  
7. (a) Perdóname.  
(b) ¿Quién se quejó?  
(c) ¿Cuándo se enfermó?  
(d) Lo siento mucho.

8. (a) Sí, faltaron algunos.  
 (b) No, no tenemos que ir.  
 (c) No, la recepción es muy buena.  
 (d) Sí, necesita reparaciones.
9. (a) Sí, porque estoy muy cansado.  
 (b) No, porque estoy muy cansado.  
 (c) Sí, siempre tomo té temprano.  
 (d) No, siempre como temprano.
10. (a) No, no necesita reparaciones.  
 (b) Él nunca llega tarde.  
 (c) No puedo, es demasiado temprano.  
 (d) No se preocupe.

MODULE 4

FRAME 3

LESSON 21

LISTENING COMPREHENSION EXERCISE B

Listen to each of the following Spanish broadcasts. First, transcribe everything in the space provided; second, circle all the words in each that you do not recognize; and third, use a dictionary to translate each of the unfamiliar words into English. Copy the unknown Spanish words and their translations at the bottom of the exercise.

I. \_\_\_\_\_  
 \_\_\_\_\_  
 \_\_\_\_\_  
 \_\_\_\_\_  
 \_\_\_\_\_

II. \_\_\_\_\_  
 \_\_\_\_\_  
 \_\_\_\_\_  
 \_\_\_\_\_  
 \_\_\_\_\_

III.

---

---

---

---

---

---

MODULE 4

FRAME 3

LESSON 21

LISTENING COMPREHENSION EXERCISE C

Write the following numbers in Arabic numerals.

- |     |       |    |       |    |       |
|-----|-------|----|-------|----|-------|
| 1.  | _____ | 2. | _____ | 3. | _____ |
| 4.  | _____ | 5. | _____ | 6. | _____ |
| 7.  | _____ | 8. | _____ | 9. | _____ |
| 10. | _____ |    |       |    |       |

END OF FRAME 3

NOTE: Do not do the Vocabulary Practice until you have completed the Narrative and the Review Exercises.

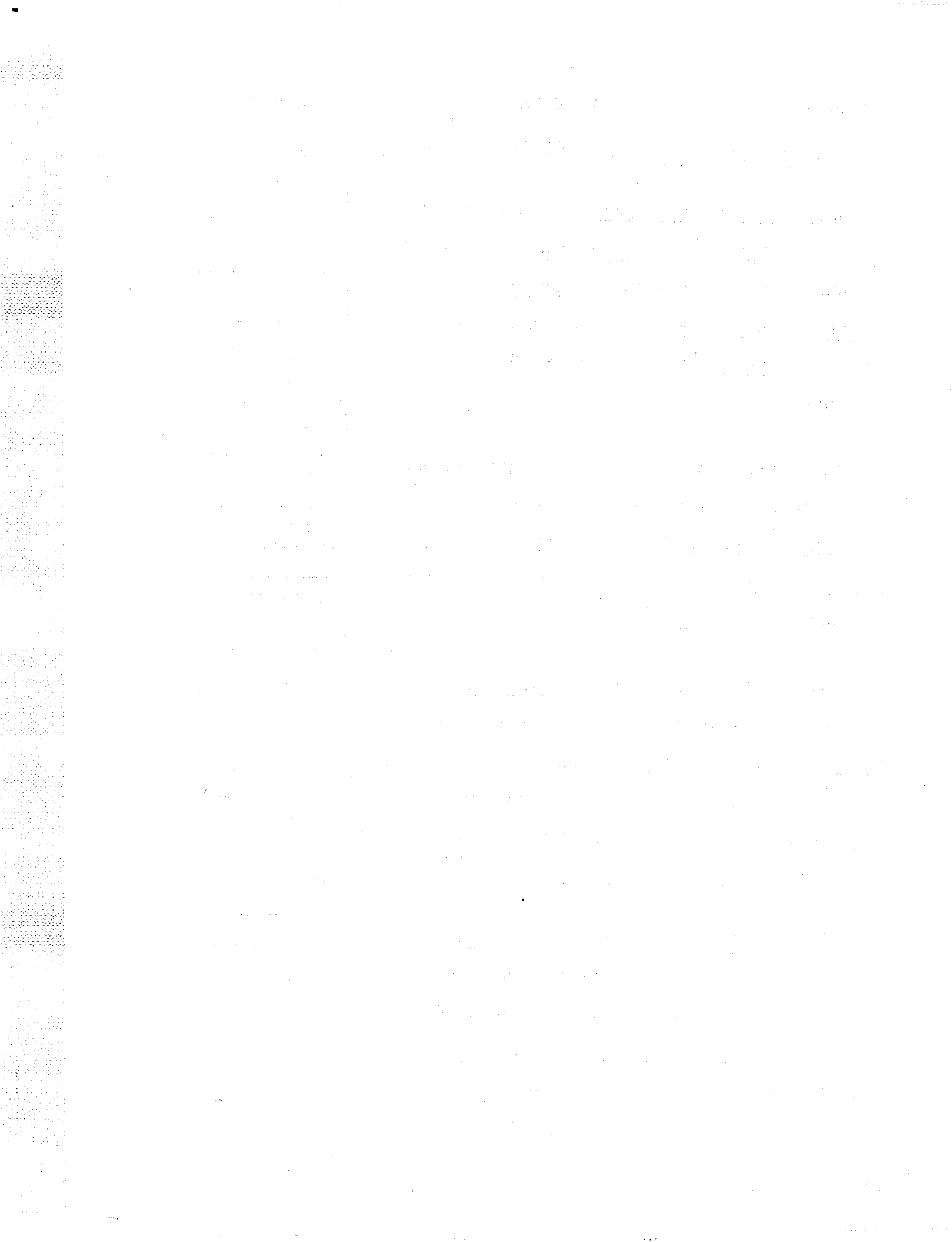



GRAVE<sup>1</sup> CONGESTIÓN<sup>2</sup> DE TRÁNSITO EN RÍO DE JANEIRO

El acelerado<sup>3</sup> incremento<sup>4</sup> en el número de vehículos amenaza<sup>5</sup> con paralizar<sup>6</sup> el tránsito de esta ciudad, donde los cariocas<sup>7</sup> están obligados<sup>8</sup> a reducir<sup>9</sup> la velocidad de sus autos a un máximo<sup>10</sup> de quince kilómetros por hora.

Un famoso técnico<sup>11</sup> advirtió que en menos de un año los vehículos no van a poder circular,<sup>12</sup> debido a<sup>13</sup> los enormes<sup>14</sup> congestionamientos<sup>15</sup> de tránsito que ocurren diariamente a ciertas<sup>16</sup> horas.

Roberto Costa da Silva, Coordinador<sup>17</sup> de Tránsito de Guanabara, declaró que ya existen<sup>18</sup> esos síntomas<sup>19</sup> fatales.<sup>20</sup> Además, culpó<sup>21</sup> de estos problemas de tránsito al automovilista<sup>22</sup> particular,<sup>23</sup> al que él llama "el demonio<sup>24</sup> urbano."<sup>25</sup>

El Departamento de Tránsito otorga<sup>26</sup> diariamente licencias de manejar a cien automovilistas particulares, en una ciudad donde el índice<sup>27</sup> de dueños<sup>28</sup> de automóvil sube a cerca del 10% de la población.<sup>29</sup>

- 1 serious  
2 \_\_\_\_\_  
3 \_\_\_\_\_  
4 \_\_\_\_\_  
\*5 threatens  
6 \_\_\_\_\_  
7 people from Rio de Janeiro  
8 forced; compelled  
9 \_\_\_\_\_  
10 \_\_\_\_\_  
11 technician  
12 \_\_\_\_\_  
\*13 due to; because of  
14 \_\_\_\_\_  
15 congestion; jam  
16 \_\_\_\_\_  
17 \_\_\_\_\_  
18 \_\_\_\_\_  
19 \_\_\_\_\_  
20 \_\_\_\_\_  
21 he blamed  
\*22 motorist; driver  
\*23 private  
24 \_\_\_\_\_  
25 \_\_\_\_\_  
26 grants  
27 index  
\*28 owners  
29 population

7. What nickname does he have for private car owners?  
\_\_\_\_\_
8. How many private drivers licenses are issued daily in Rio?  
\_\_\_\_\_
9. What do technicians believe will greatly help this traffic problem?  
\_\_\_\_\_  
\_\_\_\_\_
10. How many people will use the new Transit System?  
\_\_\_\_\_
11. How many people presently ride buses?  
\_\_\_\_\_
12. The authorities mention two reasons that particularly contribute to traffic jams. What are they?  
\_\_\_\_\_  
\_\_\_\_\_

Write English translations for the first five sentences and Spanish translations for the last five.

1. Se asustó cuando vio la cola de automovilistas que se dirigían al centro.

---

---

2. ¿Te pones nervioso cuando un policía te para para darte una multa?

---

---

3. En este estado hay más de diez millones de dueños de automóviles particulares.

---

---

4. A Juan le faltan energías porque se enfermó el mes pasado.

---

---

5. Esta mañana me equivoqué; tenía que ir al auditorio pero me quedé acá adentro.

---

---

6. She complained that the gift was somewhat small and that she received it too late.

---

---

7. Get dressed (fam.), or we're going to be late.

\_\_\_\_\_

8. Don't forget to knock (at the door).

\_\_\_\_\_

9. He drives a private car.

\_\_\_\_\_

10. One candidate was absent, and two didn't arrive on time.

\_\_\_\_\_

MODULE 4

REVIEW EXERCISE B

LESSON 21

Fill in the spaces with the Spanish equivalents of the English words or phrases indicated in parentheses.

1. José, (forget about) \_\_\_\_\_ eso.

2. Para fin de año van a tener más de (two million) \_\_\_\_\_.

3. No le dan la licencia, (because of the fines) \_\_\_\_\_ que recibí.

4. (He became very happy) \_\_\_\_\_ cuando recibí sus nuevas órdenes.

5. Mi vida, (call me) \_\_\_\_\_ mañana por la noche entre ocho y nueve.

6. (Get up (fam.)) \_\_\_\_\_ temprano, porque tenemos que llegar al aeropuerto a las seis.

7. En ese almacén podemos hacer nuestras (purchases)

\_\_\_\_\_.

8. ¿Con qué te (threatened) \_\_\_\_\_ el ladrón?
9. En esta zona hay solamente (private houses) \_\_\_\_\_.
10. Yo no (worry) \_\_\_\_\_ tanto como él.
11. Ellos me (warned) \_\_\_\_\_ del problema.
12. Tú (make mistakes) \_\_\_\_\_ muy poco cuando hablas español.
13. (We're missing) \_\_\_\_\_ algunas piezas de repuesto.
14. Yo no (scared him) \_\_\_\_\_ ; él (got scared) \_\_\_\_\_ solo.
15. Él es (the owner) \_\_\_\_\_ de los Transportes San Andrés.
16. (Stand up (fam.) ) \_\_\_\_\_, que ahí viene el general.
17. Yo nunca (get sick) \_\_\_\_\_ del estómago.
18. Eso no (matters) \_\_\_\_\_.
19. (We have little left) \_\_\_\_\_ para terminar el proyecto.
20. Victoria dice que (it is necessary) \_\_\_\_\_ ir a la reunión.

Listen to the following words from the Narrative for this lesson. Each will be given twice; once in isolation and once in a complete sentence. Translate each of the sentences into English.

1. \_\_\_\_\_
2. \_\_\_\_\_
3. \_\_\_\_\_
4. \_\_\_\_\_
5. \_\_\_\_\_
6. \_\_\_\_\_
7. \_\_\_\_\_
8. \_\_\_\_\_
9. \_\_\_\_\_
10. \_\_\_\_\_

**LESSON 22**

**STUDENT'S WORKBOOK.**

**MODULE 4**

LISTENING COMPREHENSION EXERCISE A

Listen to each of the following Spanish sentences. First, transcribe each sentence in the space provided; and second, write an English translation for each.

- 1. \_\_\_\_\_  
\_\_\_\_\_
- 2. \_\_\_\_\_  
\_\_\_\_\_
- 3. \_\_\_\_\_  
\_\_\_\_\_
- 4. \_\_\_\_\_  
\_\_\_\_\_
- 5. \_\_\_\_\_  
\_\_\_\_\_
- 6. \_\_\_\_\_  
\_\_\_\_\_
- 7. \_\_\_\_\_  
\_\_\_\_\_
- 8. \_\_\_\_\_  
\_\_\_\_\_



9.

\_\_\_\_\_

\_\_\_\_\_

10.

\_\_\_\_\_

\_\_\_\_\_

11.

\_\_\_\_\_

\_\_\_\_\_

12.

\_\_\_\_\_

\_\_\_\_\_

13.

\_\_\_\_\_

\_\_\_\_\_

14.

\_\_\_\_\_

\_\_\_\_\_

15.

\_\_\_\_\_

\_\_\_\_\_

## READING COMPREHENSION EXERCISE B

Read the following short paragraphs and circle the letter that makes true statements about each.

We had (a) an inspection.  
 (b) a party.  
 (c) a test.  
 (d) an orientation.

He doesn't

- (a) play the piano.
- (b) talk much.
- (c) drink.
- (d) dance.

He said to the captain,

- "I haven't been offered a drink."
- "Don't ask me any more."
- "Don't ask me why."
- "I don't know these people."

He gave me many

- (a) drinks.
- (b) things.
- (c) thanks.
- (d) records.

They all were

- (a) busy.
  - (b) high.
  - (c) tired.
  - (d) bored.
- 
- (a) I didn't go to work.
  - (b) something strange happened.
  - (c) Alicia got up late.
  - (d) I couldn't remember anything.

EXERCISE A

Read the following questions. Circle the correct answer for each.

## LISTENING COMPREHENSION EXERCISE B

Listen to the following news broadcasts, and circle the letters of the choices which make true statements about each. Guess at the meanings of any new words. These will be listed for you in the Key.

- I. 1. The newspaper article deals with
- (a) astronauts' training.
  - (b) a Skylab-2 mission.
  - (c) space medicine.
  - (d) a new Mexican observatory.
2. They observed the territory in order to
- (a) develop new cities.
  - (b) fight pollution.
  - (c) find geothermic sources.
  - (d) detect minerals.
- II. 1. The Congress won't authorize a tax raise
- (a) because the taxpayers protested.
  - (b) and the President agrees.
  - (c) because the advisor was opposed.
  - (d) now that the war is over.
2. The advisor expressed his views
- (a) during an official reception.
  - (b) in a press conference at the White House.
  - (c) during his recent trip to Mexico.
  - (d) in a televised interview.
3. It appears that the greatest shortage is of
- (a) gas.
  - (b) water.
  - (c) heating fuels.
  - (d) wheat and other cereals.

## LISTENING COMPREHENSION EXERCISE C

Listen to each of the following number phrases. Write only the numbers in Arabic numerals. Do not write any other words.

- |           |          |          |
|-----------|----------|----------|
| 1. _____  | 2. _____ | 3. _____ |
| 4. _____  | 5. _____ | 6. _____ |
| 7. _____  | 8. _____ | 9. _____ |
| 10. _____ |          |          |

END OF FRAME 2

MEMORANDUM FOR THE RECORD

1. On 15 October 1954, the following information was received from the [redacted] regarding the activities of [redacted] in the [redacted] area.

2. [redacted] is a [redacted] who has been active in the [redacted] area since [redacted]. He is currently [redacted] and is [redacted] with [redacted].

3. [redacted] is a [redacted] who has been active in the [redacted] area since [redacted]. He is currently [redacted] and is [redacted] with [redacted].

4. [redacted] is a [redacted] who has been active in the [redacted] area since [redacted]. He is currently [redacted] and is [redacted] with [redacted].

5. [redacted] is a [redacted] who has been active in the [redacted] area since [redacted]. He is currently [redacted] and is [redacted] with [redacted].

6. [redacted] is a [redacted] who has been active in the [redacted] area since [redacted]. He is currently [redacted] and is [redacted] with [redacted].

7. [redacted] is a [redacted] who has been active in the [redacted] area since [redacted]. He is currently [redacted] and is [redacted] with [redacted].

8. [redacted] is a [redacted] who has been active in the [redacted] area since [redacted]. He is currently [redacted] and is [redacted] with [redacted].

9. [redacted] is a [redacted] who has been active in the [redacted] area since [redacted]. He is currently [redacted] and is [redacted] with [redacted].

10. [redacted] is a [redacted] who has been active in the [redacted] area since [redacted]. He is currently [redacted] and is [redacted] with [redacted].

11. [redacted] is a [redacted] who has been active in the [redacted] area since [redacted]. He is currently [redacted] and is [redacted] with [redacted].

LISTENING COMPREHENSION EXERCISE A

Listen to each of the following Spanish sentences. First, transcribe each sentence in the space provided; and second, write an English translation for each.

1. \_\_\_\_\_  
\_\_\_\_\_
2. \_\_\_\_\_  
\_\_\_\_\_
3. \_\_\_\_\_  
\_\_\_\_\_
4. \_\_\_\_\_  
\_\_\_\_\_
5. \_\_\_\_\_  
\_\_\_\_\_
6. \_\_\_\_\_  
\_\_\_\_\_
7. \_\_\_\_\_  
\_\_\_\_\_
8. \_\_\_\_\_  
\_\_\_\_\_
9. \_\_\_\_\_  
\_\_\_\_\_
10. \_\_\_\_\_  
\_\_\_\_\_

## LISTENING COMPREHENSION EXERCISE B

Listen to the following news broadcasts and circle the letters of the choices that make true statements about each. Guess at the meanings of any new words. These will be listed for you in the Key.

- I. 1. They are going to hold
- (a) a field and track competition.
  - (b) the Olympic games.
  - (c) a series of discussions.
  - (d) a film festival.
2. The event will take place in
- (a) Albania.
  - (b) Bulgaria.
  - (c) Hungary.
  - (d) Romania.
3. This event will start
- (a) next year.
  - (b) next month on the 1st.
  - (c) next month on the 5th.
  - (d) next week.
4. During this event some participants will
- (a) set new records.
  - (b) watch movies.
  - (c) win medals.
  - (d) discuss the issues.
5. Those attending include
- (a) a Cuban delegation.
  - (b) amateurs.
  - (c) a Soviet envoy.
  - (d) professionals.

- II. 1. The news comes from
- (a) Mexico.
  - (b) Naples.
  - (c) Texas.
  - (d) Washington.
2. The news broadcast deals with
- (a) a contagious disease center in Texas.
  - (b) a case of cholera in the U. S. A.
  - (c) U. S. authorities in Naples.
  - (d) hospitals in Texas without patients.
- III. 1. According to this newscast, the U. S. A. represents
- (a) 6% of the population of the world.
  - (b) consumes 14% of the world's oil production.
  - (c) produces one third of the world's petroleum.
  - (d) owns 40% of the world's total energy resources.
2. The report states
- (a) road signs are not always clear to drivers.
  - (b) many international roads are closed to traffic.
  - (c) many run out of gas in the middle of the road.
  - (d) 6% of the vehicles are stopped and searched.

END OF FRAME 3

NOTE: Do not do the Vocabulary Practice until you have completed the Narrative and the Review Exercises.





El Mayor Fernando Vega y  
Concepción Sarmiento de Vega  
tienen el gusto de invitar a Ud. y a su  
esposa a la cena que tendrá lugar  
el sábado 18 de noviembre  
en su residencia de la Avenida  
Mariscal Estigarribia Num. 13  
a las Veinte horas.

R/Mayor Fernando Vega  
Av. Mariscal Estigarribia Num. 13  
Santa Catalina, 7

Señor Pedro Sánchez y Señora  
Calle 46 Núm. 2110,  
Marina



NOTAS SOCIALES<sup>1</sup>

Ayer por la noche, los esposos Vega ofrecieron una comida a un grupo<sup>2</sup> de sus amistades<sup>3</sup> con motivo del<sup>4</sup> reciente ascenso del señor Vega, quien ahora ostenta<sup>5</sup> el grado de mayor del Ejército de Amerindia.

A la cena asistieron conocidas<sup>6</sup> personalidades<sup>7</sup> del círculo<sup>8</sup> militar de nuestra sociedad.<sup>9</sup>

Entre los invitados<sup>10</sup> se encontraban<sup>11</sup> los padres de Conchita, — el coronel Baldomero Sarmiento, Comandante de la Zona Nordeste del país, y su esposa Encarnación Valencia de Sarmiento, — el coronel Gustavo Olavarría, el capitán Pedro Sánchez y su esposa, el mayor Gerardo Plascencia y su señora, así como<sup>12</sup> el mayor Mark Anderson y el capitán Matías Pérez González, oficiales del Ejército de los Estados Unidos, quienes se hallan<sup>13</sup> en la capital para coordinar<sup>14</sup> los planes iniciales de la Operación Unidad.

\*1  
\_\_\_\_\_\*2  
\_\_\_\_\_<sup>3</sup>friends\*4  
on the occasion of the<sup>5</sup>shows  
(proudly)<sup>6</sup>(well) known7  
\_\_\_\_\_8  
\_\_\_\_\_9  
\_\_\_\_\_\*10  
guests\*11  
were\*12  
as well as<sup>13</sup>are\*14  
\_\_\_\_\_

Se sirvieron<sup>15</sup> bebidas hasta las nueve  
de la noche, hora en que todos pasaron a  
los jardines de la hermosa<sup>16</sup> residencia  
para disfrutar de<sup>17</sup> una deliciosa<sup>18</sup> cena  
al aire libre.<sup>19</sup>

<sup>15</sup> they (were)  
served

\*<sup>16</sup> beautiful

<sup>17</sup> enjoy

<sup>18</sup> \_\_\_\_\_

<sup>19</sup> outdoors

MODULE 4                      EXERCISE A FOR NARRATIVE A                      LESSON 22

Some of the numbered underlined words in the Narrative have English cognates. These have not been translated for you, but numbered spaces have been provided in the margin. Go back to the Narrative and guess at the meaning of each of the cognates. Write your guesses in the appropriate spaces, then check your answers with the Key.

MODULE 4                      EXERCISE B FOR NARRATIVE A                      LESSON 22

Write Spanish answers to the following questions based on the Narrative. This exercise is intended to develop your reading comprehension and writing skills. Therefore, it is to your advantage to answer the questions as explicitly as possible. Don't limit your answers to short responses.

1. ¿Qué hicieron los Vega ayer por la noche?

---

---

2. ¿Quiénes asistieron?

---

---

3. ¿Qué familiares de los Vega se encontraban entre los invitados?

---

---

4. ¿Qué van a hacer los oficiales norteamericanos en Amerindia?

---

---

5. ¿Dónde se sirvió la cena?

---

---

100-100000

100-100000

100-100000

100-100000

100-100000

100-100000

100-100000

100-100000

100-100000

100-100000

100-100000

100-100000

100-100000

100-100000

100-100000

100-100000

100-100000

100-100000

100-100000

100-100000

100-100000

100-100000

100-100000

100-100000

100-100000

100-100000

100-100000

100-100000

100-100000

100-100000

100-100000

100-100000

100-100000

100-100000

100-100000

100-100000

100-100000

100-100000

100-100000

100-100000

100-100000

100-100000

100-100000

100-100000

100-100000

100-100000

100-100000

100-100000

100-100000

100-100000

100-100000

100-100000

100-100000

100-100000

100-100000

100-100000

100-100000

100-100000

100-100000

100-100000

100-100000

100-100000

100-100000

100-100000

100-100000

100-100000

100-100000

100-100000

100-100000

UN COCTEL<sup>1</sup>

1 \_\_\_\_\_

La señora María del Carmen Palomino ofreció un coctel con motivo de la inauguración<sup>2</sup> de su nueva tienda en la Avenida de los Insurgentes. Al acto<sup>3</sup> asistieron numerosos amigos y clientes.<sup>4</sup> El Reverendo<sup>5</sup> Padre Pascual Caro bendijo<sup>6</sup> el nuevo local.<sup>7</sup> Se sirvieron vinos y quesos,<sup>8</sup> y en repetidas<sup>9</sup> ocasiones<sup>10</sup> los invitados brindaron<sup>11</sup> con champaña.<sup>12</sup> El presidente de la Asociación<sup>13</sup> de Comerciantes<sup>14</sup> de la Zona Noreste estuvo presente en la reunión.

2 (grand) opening  
 3 event  
 \*4 \_\_\_\_\_  
 5 \_\_\_\_\_  
 6 blessed  
 7 premises  
 \*8 cheeses  
 9 \_\_\_\_\_  
 10 \_\_\_\_\_  
 11 toasted  
 12 \_\_\_\_\_  
 13 \_\_\_\_\_  
 14 merchants

Some of the numbered underlined words in the Narrative have English cognates. These have not been translated for you, but numbered spaces have been provided in the margin. Go back to the Narrative and guess at the meaning of each of the cognates. Write your guesses in the appropriate spaces, then check your answers with the Key.



Circle the letter of the choice that makes a true statement about the Narrative.

1. Maria del Carmen Palomino

- (a) sold her store.
- (b) got married.
- (c) gave a party.
- (d) drank a cocktail.

2. Maria del Carmen's friends

- (a) helped her sell the store.
- (b) helped her celebrate.
- (c) elected her president of the association.
- (d) made several purchases.

3. Father Pascual Caro

- (a) blessed the new premises.
- (b) supported the local merchants.
- (c) didn't have any wine.
- (d) has been there on repeated occasions.

4. Maria del Carmen and her friends

- (a) went into business together.
- (b) finished up all the wine.
- (c) planned the evening's events.
- (d) gave toasts with champagne.

Translate the words and phrases in parentheses into Spanish.

1. Tú siempre \_\_\_\_\_ a dónde ibas.  
(used to tell me)
2. ¡No \_\_\_\_\_ eso, Juanita!  
(say)
3. Doña Encarnación, ¡ \_\_\_\_\_ todavía!  
(don't leave)
4. Esa muchacha es demasiado alta; me gusta más  
\_\_\_\_\_ vestido rojo.  
(the one in the)
5. ¡ \_\_\_\_\_ están esos cuadros!  
(How pretty)
6. Yo no sabía \_\_\_\_\_ la fiesta.  
(the [thing] about)
7. Tu amigo es muy \_\_\_\_\_.  
(nice)
8. Él es \_\_\_\_\_, también.  
(good looking)
9. \_\_\_\_\_ en la esquina, mi vida.  
(Do not wait for me)
10. \_\_\_\_\_ después de las ocho, Pepito.  
(Do not come back)

Listen to the following words from the Narrative for this lesson. Each will be given twice; once in isolation and once in a complete sentence. Translate each of the complete sentences into English.

1. \_\_\_\_\_
2. \_\_\_\_\_
3. \_\_\_\_\_
4. \_\_\_\_\_
5. \_\_\_\_\_
6. \_\_\_\_\_
7. \_\_\_\_\_
8. \_\_\_\_\_
9. \_\_\_\_\_
10. \_\_\_\_\_

LESSON 23

STUDENT'S WORKBOOK

MODULE 4



## LISTENING COMPREHENSION EXERCISE A

Listen to each of the following Spanish questions or statements. Circle the letter of the best response for each.

1. (a) No puedes ir tan temprano.  
(b) No puedo ir a esa hora.  
(c) Ven a las cuatro y cuarto  
(d) Vienen todos.
  
2. (a) No debo pedir nada.  
(b) No debo dar nada.  
(c) No debo decir nada.  
(d) No debo escribir nada.
  
3. (a) Ya voy.  
(b) No venga.  
(c) No vaya.  
(d) Ya viene.
  
4. (a) No puedo dejar todo.  
(b) No quiero registrar todo.  
(c) No quiero cerrar todo.  
(d) No puedo poner todo.
  
5. (a) No puedo salir tan temprano.  
(b) No puedo comer tan temprano.  
(c) Me gustaba más antes.  
(d) Me gusta sin sal.
  
6. (a) No compré nada.  
(b) Nunca la tomo.  
(c) Voy a tratar.  
(d) Lo tengo en el automóvil.
  
7. (a) ¿Qué hacen?  
(b) Yo tengo unos mapas.  
(c) Es un mapa grande.  
(d) ¿Dónde le enseñaron?

8. (a) Yo lo hago.  
(b) Sí, hay algo.  
(c) No haga nada por ahora.  
(d) Esto no puede perderse.
9. (a) ¿En ese cenicero?  
(b) Aquí fuman mucho  
(c) Aquí hay cigarrillos.  
(d) ¿Las pongo aquí?
10. (a) En el almuerzo.  
(b) No sé; no tengo reloj.  
(c) Voy a decirle a las cinco.  
(d) Ahora no me dicen nada.

MODULE 4

FRAME 1

LESSON 23

LISTENING COMPREHENSION EXERCISE B

Listen to each of the following Spanish sentences. First, transcribe each sentence in the space provided; and second, write an English translation for each.

1. \_\_\_\_\_  
\_\_\_\_\_
2. \_\_\_\_\_  
\_\_\_\_\_
3. \_\_\_\_\_  
\_\_\_\_\_
4. \_\_\_\_\_  
\_\_\_\_\_
5. \_\_\_\_\_  
\_\_\_\_\_

6. \_\_\_\_\_  
\_\_\_\_\_
7. \_\_\_\_\_  
\_\_\_\_\_
8. \_\_\_\_\_  
\_\_\_\_\_
9. \_\_\_\_\_  
\_\_\_\_\_
10. \_\_\_\_\_  
\_\_\_\_\_

MODULE 4

FRAME 1

LESSON 23

LISTENING COMPREHENSION EXERCISE C

Write the following numbers in Arabic numerals.

1. \_\_\_\_\_ 2. \_\_\_\_\_ 3. \_\_\_\_\_
4. \_\_\_\_\_ 5. \_\_\_\_\_ 6. \_\_\_\_\_
7. \_\_\_\_\_ 8. \_\_\_\_\_ 9. \_\_\_\_\_
10. \_\_\_\_\_

END OF FRAME 1



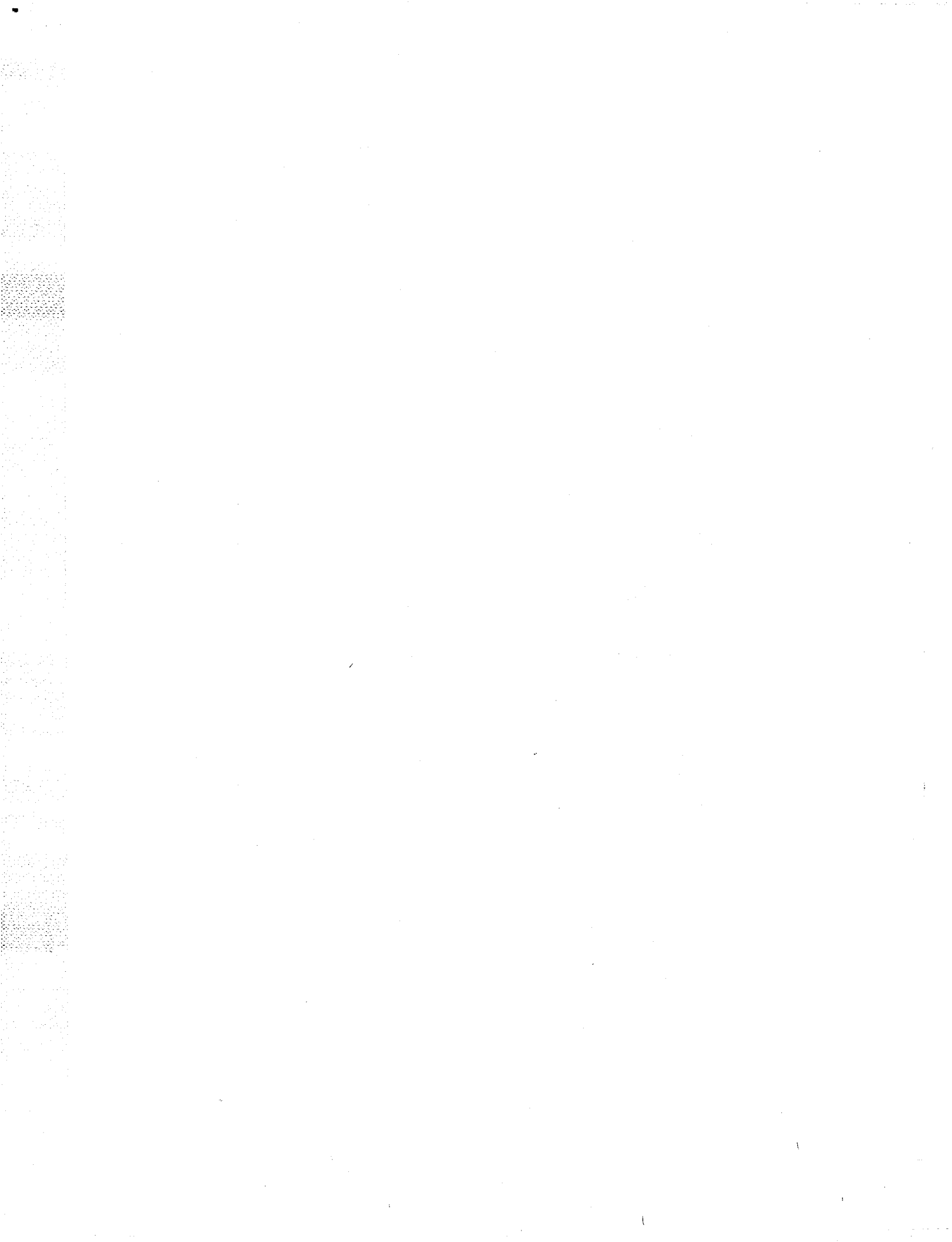

## LISTENING COMPREHENSION EXERCISE A

Listen to each of the following sentences and write short answers in Spanish to the questions written in your workbook.

1. ¿Qué le falta a Villa?

---

2. ¿Cuándo tiene que ir?

---

3. ¿Qué va a hacer él?

---

4. ¿Qué es lo que él pregunta?

---

5. ¿A dónde va a ir Villa?

---

6. ¿Qué va a hacer para hablar con Gómez?

---

7. ¿Qué necesitan llevar?

---

8. ¿Qué hizo Enrique?

---

9. ¿Qué necesitaba Alicia?

---

10. ¿Por qué no quiere ese plano?

---

## LISTENING COMPREHENSION EXERCISE B

Listen to each of the following Spanish newscasts. First, transcribe everything in the space provided; second, circle all the words in each that you do not recognize; and third, use a dictionary to translate each of the unfamiliar words into English. Write the unfamiliar words and their translations at the bottom of each transcription.

1.

---

---

---

---

---

---

2.

---

---

---

---

---

---

3.

---

---

---

---

---

---

4.

---

---

---

---

---

---

5.

---

---

---

---

---

---

MODULE 4

FRAME 2

LESSON 23

LISTENING COMPREHENSION EXERCISE C

Listen to the following Spanish sentences and circle the letter of the best English translation.

1. (a) He met a very competent doctor.  
(b) He got a very competent doctor.  
(c) He consulted a very competent doctor.  
(d) He followed a very competent doctor.
  
2. (a) Yesterday they elected a governor.  
(b) Yesterday they saw the governor.  
(c) Yesterday they met the governor.  
(d) Yesterday they received a governor.
  
3. (a) He serves what he wants.  
(b) He knows what he wants.  
(c) He says what he wants.  
(d) He gets what he wants.

4. (a) Why did you get that key?  
(b) What did you use that key for?  
(c) What's that wrench (good) for?  
(d) Why do you use that wrench?
  
5. (a) The Marine called the aide.  
(b) The sailor asked for help.  
(c) The sailor gave first aid.  
(d) The Marine gave his helper an order.
  
6. (a) That map is of no use to me.  
(b) I don't like that map.  
(c) I can't follow that map.  
(d) That map isn't the same one.
  
7. They gave him  
(a) a hand.  
(b) a mission.  
(c) a suitcase.  
(d) a fine.
  
8. (a) They weren't used to crossing mountains.  
(b) They didn't follow the road through the plains.  
(c) They didn't get to go through those plains.  
(d) They didn't manage to cross those mountains.
  
9. (a) See it and come right back.  
(b) Read it and come right away.  
(c) Go and come back right away.  
(d) Greet him and come right back.
  
10. (a) Thanks for the favor.  
(b) Do me a favor.  
(c) He asked me for a favor.  
(d) I needed a favor.

END OF FRAME 2

## LISTENING COMPREHENSION EXERCISE A

Transcribe each of the following Spanish questions. Then write a complete answer for each. After you complete the exercise, have your teacher check your responses.

1. \_\_\_\_\_  
\_\_\_\_\_
2. \_\_\_\_\_  
\_\_\_\_\_
3. \_\_\_\_\_  
\_\_\_\_\_
4. \_\_\_\_\_  
\_\_\_\_\_
5. \_\_\_\_\_  
\_\_\_\_\_
6. \_\_\_\_\_  
\_\_\_\_\_
7. \_\_\_\_\_  
\_\_\_\_\_

## LISTENING COMPREHENSION EXERCISE B

Translate each of the following Spanish sentences:

1. \_\_\_\_\_
2. \_\_\_\_\_
3. \_\_\_\_\_
4. \_\_\_\_\_
5. \_\_\_\_\_
6. \_\_\_\_\_
7. \_\_\_\_\_
8. \_\_\_\_\_
9. \_\_\_\_\_
10. \_\_\_\_\_
11. \_\_\_\_\_
12. \_\_\_\_\_
13. \_\_\_\_\_
14. \_\_\_\_\_

END OF FRAME 3

NOTE: Do not do the Vocabulary Practice until you have completed the Narrative and Review Exercises.





# MAPA DE LA REPÚBLICA DE AMERINDIA

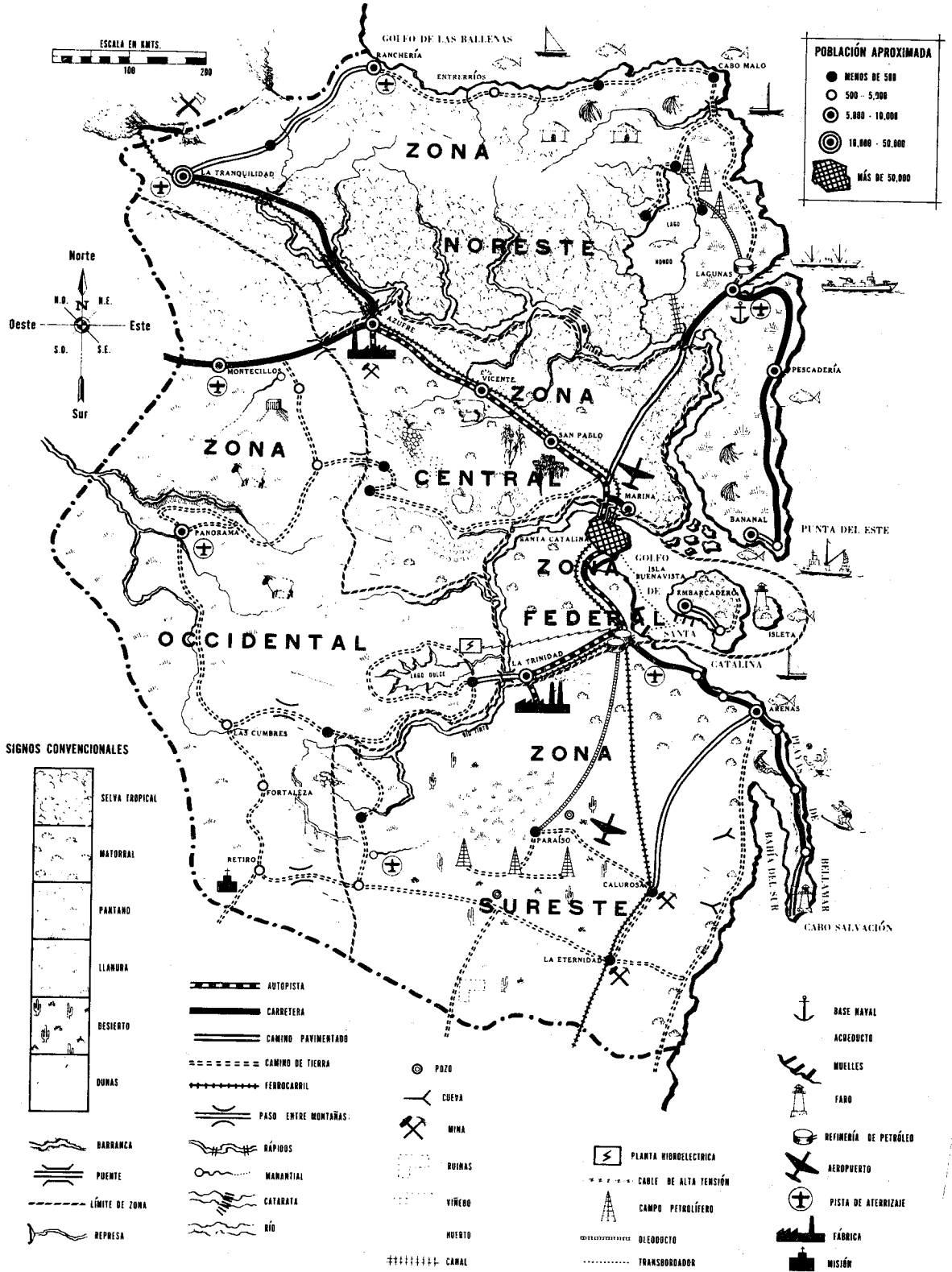

Look at the map of Amerindia and write answers in Spanish to the following questions.

1. ¿Qué tipos de terreno hay en este país? types  
\_\_\_\_\_
2. ¿Al suroeste de qué ciudad hay viñedos? vineyards  
\_\_\_\_\_
3. ¿En qué zona hay más selvas tropicales\*? tropical jungles  
\_\_\_\_\_
4. ¿Qué medios de comunicación hay entre Catalina y La Trinidad? means of communication  
\_\_\_\_\_
5. ¿Qué símbolos topográficos hay entre los puertos de Marina y de Lagunas? symbols  
\_\_\_\_\_
6. ¿Qué clase de camino hay entre Retiro y Las Cumbres?  
\_\_\_\_\_
7. ¿Qué accidentes del terreno ve uno entre Las Cumbres y La Trinidad? features  
\_\_\_\_\_
8. ¿En qué río se encuentran las cataratas de este país? are found waterfalls  
\_\_\_\_\_
9. ¿Qué hay al lado de la represa que construyeron en el lago Dulce?  
\_\_\_\_\_

10. ¿Qué quieren decir los símbolos en forma de "Y" al sur de Arenas?
- 
11. ¿Qué ciudades quedan en la región donde hay más huertos? orchards
- 
12. ¿Qué construyeron para llevar agua del lago Dulce a la costa?
- 
13. ¿De dónde y en qué traen petróleo\* para las refinerías de la Zona Federal? oil refineries
- 
14. ¿En qué lugares de la costa hay muelles\*? docks; wharfs
- 
15. ¿Qué usan para la transmisión de energía eléctrica desde la planta del lago Dulce?
- 
16. ¿Dónde queda la isla\* de Buenavista? island
- 
17. ¿Qué tipos de terreno tiene que cruzar un avión en línea\* directa de Azufre a Cabo Malo? line
- 
18. ¿Qué une el lago Hondo con el río Salado? unites; joins
- 
19. ¿Cuál es la pista de aterrizaje\* que queda más al norte? landing strip
- 
20. ¿Dónde queda la Bahía\* del Sur? bay
-

Fill in each space with the Spanish equivalent of the English word or phrase indicated in parentheses.

1. ¡Villa!, necesitamos las medicinas. ¡(Go familiar)  
\_\_\_\_\_ ahora mismo a recogerlas!
2. Primero, hay que estudiar los mapas (topographic)  
\_\_\_\_\_.
3. ¿Sabe Ud. cuántos documentos nos (are missing) \_\_\_\_\_?
4. ¿(Did you get) \_\_\_\_\_ los documentos que le pedí?
5. Sí, pero Ud. (forgot) \_\_\_\_\_ llamarme a las cuatro.
6. En la Zona Noreste hay muchos (swamps) \_\_\_\_\_.
7. Cuando me quedo a trabajar tarde, mi esposa (worries)  
\_\_\_\_\_ mucho.
8. ¡Pepito!, (put familiar) \_\_\_\_\_ la silla  
donde estaba antes.
9. ¿En qué (folder) \_\_\_\_\_ puso usted los planos?
10. (By the way) \_\_\_\_\_, ¿cómo es el camino entre  
Retiro y Panorama?
11. Cuando salimos de la ciudad, vimos (a dam) \_\_\_\_\_.
12. En nuestro viaje de regreso pudimos ver (the bay)  
\_\_\_\_\_.
13. El Instituto (Geodetic) \_\_\_\_\_ Interamericano  
tiene oficinas en casi todos los países hispanoamericanos.
14. ¡Mario, (tell her familiar) \_\_\_\_\_ a María  
que el baile es el sábado!

15. ¿Cuánto cobran por pasar por (the turnpike) \_\_\_\_\_  
\_\_\_\_\_?
16. No conocimos (the lake) \_\_\_\_\_.
17. ¿Qué (population) \_\_\_\_\_ tiene esta ciudad?
18. Para llegar al lago tenemos que hacer (a detour).  
\_\_\_\_\_.
19. ¡Raúl, (be so kind as to /familiar/) \_\_\_\_\_  
de no repetir eso enfrente de los niños!
20. ¿Por qué (do you eat /familiar/) \_\_\_\_\_ tanto?
21. Este río no va (to the sea) \_\_\_\_\_, va al lago Hondo.
22. ¿Están (up to date) \_\_\_\_\_ las noticias?
23. ¿Qué planta hidroeléctrica está al lado de (the coast)  
\_\_\_\_\_?
24. No hay muchas calles (paved) \_\_\_\_\_.
25. A mis niños les gusta vivir en (the country)  
\_\_\_\_\_; no les gusta la ciudad.
26. El faro está en la punta del (cape)  
\_\_\_\_\_, a la entrada del (gulf) \_\_\_\_\_.

Translate each of the following questions and write appropriate answers to them in Spanish.

1. What document do they ask for at the immigration office?

---

---

2. After eating, what do you (fam.) ask the waiter for?

---

---

3. If a policeman stops you on the freeway, what does he ask you for first?

---

---

4. Do you (all) ask your teacher for permission before leaving the classroom?

---

---

5. Whom do they elect every four years in the U. S.?

---

---

6. How many years does a recruit serve in the Air Force?

---

---

7. Do you serve dinner at the mess hall?

---

---

8. What are portfolios good for?

---

---

Listen to the following words from the Narrative for this lesson. Each will be given twice; once in isolation and once in a complete sentence. Translate each of the sentences into English.

1. \_\_\_\_\_  
\_\_\_\_\_
2. \_\_\_\_\_  
\_\_\_\_\_
3. \_\_\_\_\_  
\_\_\_\_\_
4. \_\_\_\_\_  
\_\_\_\_\_
5. \_\_\_\_\_  
\_\_\_\_\_
6. \_\_\_\_\_  
\_\_\_\_\_
7. \_\_\_\_\_  
\_\_\_\_\_

LESSON 24

STUDENT'S WORKBOOK

MODULE 4



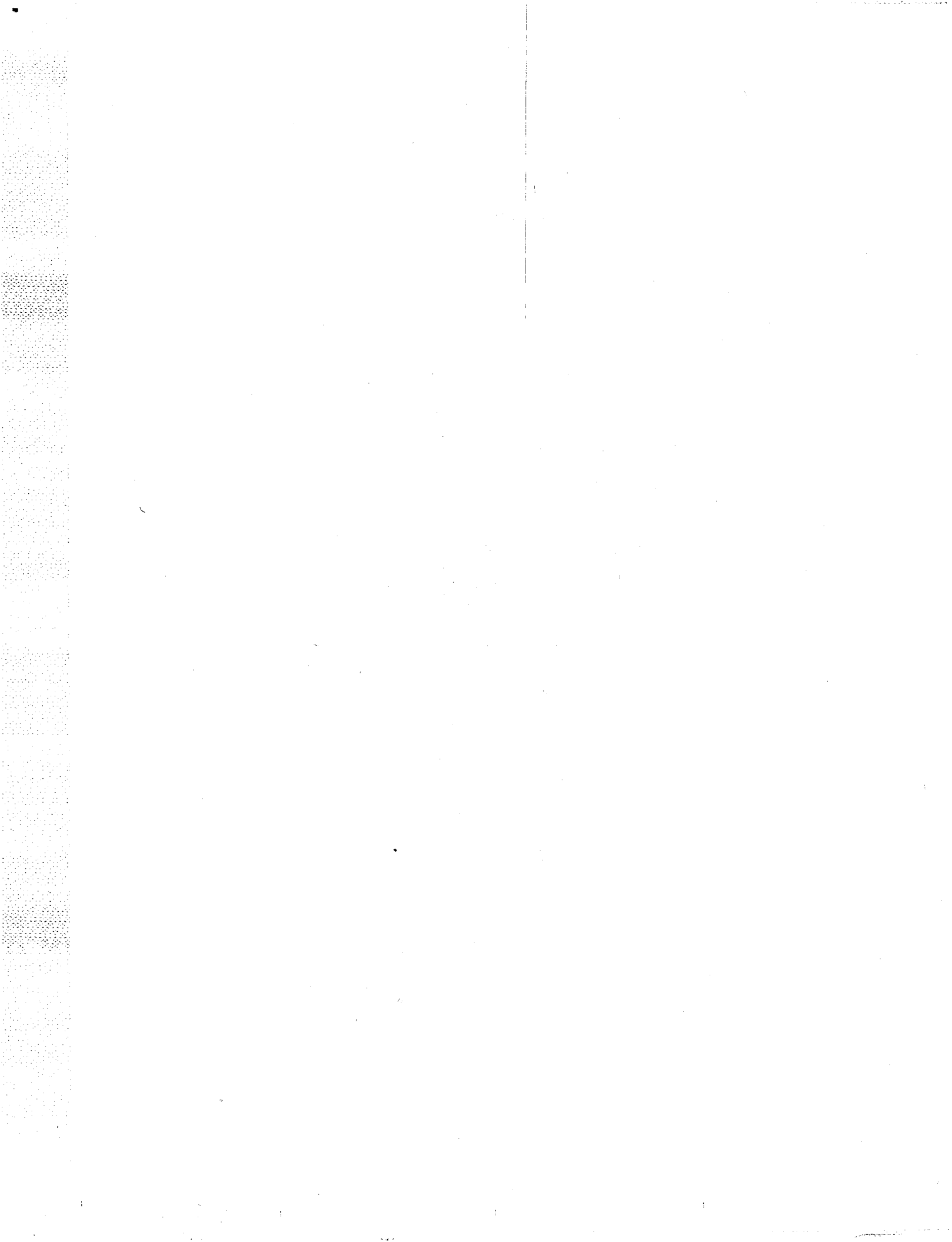

LISTENING COMPREHENSION EXERCISE A

Write an appropriate Spanish response to each of the following questions. Have your instructor check your answers when you have finished.

1. \_\_\_\_\_
2. \_\_\_\_\_
3. \_\_\_\_\_
4. \_\_\_\_\_
5. \_\_\_\_\_
6. \_\_\_\_\_
7. \_\_\_\_\_
8. \_\_\_\_\_

## LISTENING COMPREHENSION EXERCISE B

Listen to each of the following Spanish sentences. First, transcribe each sentence in the space provided; and second, write an English translation for each.

1. \_\_\_\_\_  
\_\_\_\_\_
2. \_\_\_\_\_  
\_\_\_\_\_
3. \_\_\_\_\_  
\_\_\_\_\_
4. \_\_\_\_\_  
\_\_\_\_\_
5. \_\_\_\_\_  
\_\_\_\_\_
6. \_\_\_\_\_  
\_\_\_\_\_
7. \_\_\_\_\_  
\_\_\_\_\_
8. \_\_\_\_\_  
\_\_\_\_\_

## LISTENING COMPREHENSION EXERCISE C

Listen to each of the following number phrases. Write only the numbers in Arabic numerals. Do not write any other words.

- |           |          |          |
|-----------|----------|----------|
| 1. _____  | 2. _____ | 3. _____ |
| 4. _____  | 5. _____ | 6. _____ |
| 7. _____  | 8. _____ | 9. _____ |
| 10. _____ |          |          |

END OF FRAME 1

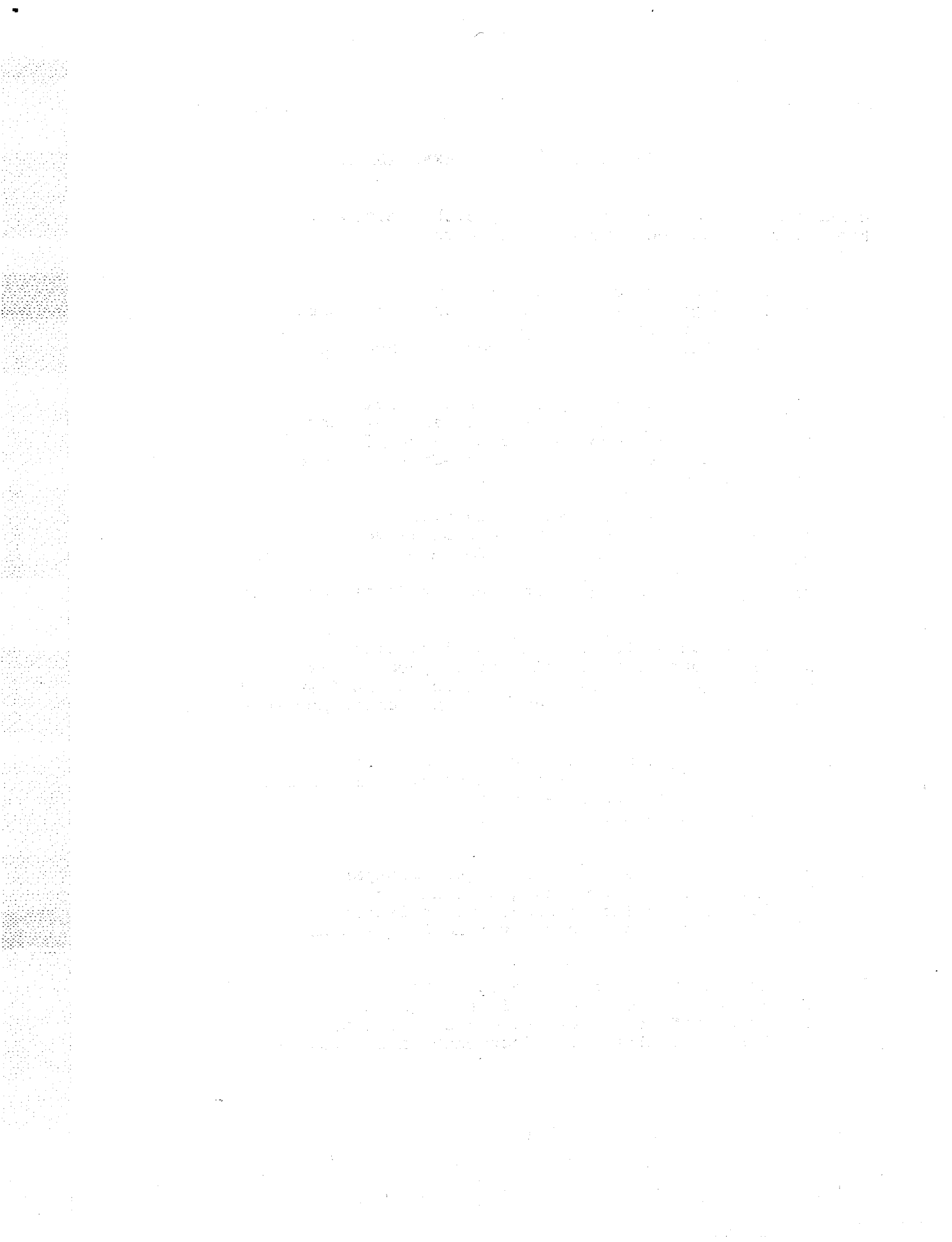

## LISTENING COMPREHENSION EXERCISE A

Listen to each of the following Spanish questions. Circle the letter of the best response to each.

1. (a) El mecánico me dijo que mi coche estaba listo.  
(b) No tengo ganas de comprarme una nueva casa.  
(c) Creo que pagué mucho por esa casa.  
(d) Sí, sólo me faltan unas cositas nada más.
  
2. (a) Estoy de acuerdo; pasemos a mi oficina.  
(b) La gente de aquí no habla de esos asuntos.  
(c) En realidad, debemos tratarnos de tú.  
(d) ¡Qué lástima que no puedes quedarte un poco!
  
3. (a) No sé a qué hora empieza la clase.  
(b) Está bien, ya que somos buenos amigos.  
(c) Hoy día, más y más gente forma parte de nuestro grupo.  
(d) Gracias a Dios que finalmente podemos hablarnos.
  
4. (a) Creo que mi teléfono no funciona bien.  
(b) Ahora que estamos solos te lo puedo decir.  
(c) ¿Por qué no contestaste cuando te llamé anoche?  
(d) Por mi parte, no me gusta mucho hablar por teléfono.
  
5. (a) Dijeron que no conocieron a ese señor.  
(b) En realidad, no sabemos quién tiene la razón.  
(c) No pudieron creer tal cosa.  
(d) Él nunca me dice la verdad.
  
6. (a) Ya estoy cansado de tener que trabajar.  
(b) A él siempre le gusta gastar dinero.  
(c) Lo que necesito no cuesta mucho dinero.  
(d) El sargento pudo comprar todo lo que quería.
  
7. (a) No recuerdo lo que puse en el maletín.  
(b) El maletín no está en el baúl del auto.  
(c) Me olvidé de la carpeta con los planos.  
(d) Tengo que llevar los documentos a la oficina.

LISTENING COMPREHENSION EXERCISE B

Listen to each of the following Spanish sentences. First, transcribe each sentence in the space provided; and second, write an English translation for each.

1. 

---

---

---
2. 

---

---

---
3. 

---

---

---
4. 

---

---

---
5. 

---

---

---
6. 

---

---

---
7. 

---

---

---

LISTENING COMPREHENSION EXERCISE C

Translate the following Spanish sentences.

1. \_\_\_\_\_

2. \_\_\_\_\_

3. \_\_\_\_\_

4. \_\_\_\_\_

5. \_\_\_\_\_

6. \_\_\_\_\_

7. \_\_\_\_\_

8. \_\_\_\_\_

END OF FRAME 2





## LISTENING COMPREHENSION EXERCISE A

Listen to each of the following sentences and write short answers in Spanish to the questions in your workbook.

1. ¿Qué deben hacer todos los oficiales?

---

2. ¿Por qué se preocupaba él?

---

3. ¿Cuánto falta para empezar la clase?

---

4. ¿Qué es lo que hay que hacer?

---

5. ¿Qué tal es la señorita López?

---

6. ¿Cuál destornillador quiere?

---

7. ¿Qué consiguió él?

---

8. ¿Qué hizo el grupo?

---

## LISTENING COMPREHENSION EXERCISE B

Listen to each of the following Spanish sentences. First, transcribe each sentence in the space provided; and second, write an English translation for each.

1. \_\_\_\_\_  
\_\_\_\_\_
2. \_\_\_\_\_  
\_\_\_\_\_
3. \_\_\_\_\_  
\_\_\_\_\_
4. \_\_\_\_\_  
\_\_\_\_\_
5. \_\_\_\_\_  
\_\_\_\_\_
6. \_\_\_\_\_  
\_\_\_\_\_
7. \_\_\_\_\_  
\_\_\_\_\_
8. \_\_\_\_\_  
\_\_\_\_\_

END OF FRAME 3

NOTE: Do not do the Vocabulary Practice until you have completed the Narrative and the Review Exercises.

EL ESPAÑOL SE CONVIERTE<sup>1</sup> EN EL SEGUNDO IDIOMA  
DE LOS ESTADOS UNIDOS

Nueva York (AP) - El español se convierte rápidamente en el segundo idioma de los Estados Unidos. La necesidad de comunicarse<sup>2</sup> con una creciente<sup>3</sup> población de habla hispana y la importancia de su uso<sup>4</sup> en los viajes y en los negocios, impulsan<sup>5</sup> a muchos norteamericanos a asistir a escuelas de idiomas.

<sup>1</sup> is becoming

2

---

<sup>3</sup> growing

4

---

<sup>5</sup> urge; motivate

Como resultado de esto, hay un gran número de escuelas que ofrecen cursos de español. Muchas de éstas utilizan<sup>6</sup> un sistema<sup>7</sup> basado<sup>8</sup> en el que formuló<sup>9</sup> un conocido grupo de lingüistas<sup>10</sup> que estuvo a cargo de la enseñanza<sup>11</sup> de idiomas a los militares norteamericanos durante la Segunda Guerra Mundial.<sup>12</sup> El nuevo sistema le da mayor<sup>13</sup> importancia a la enseñanza de la lengua hablada, y menor<sup>14</sup> importancia al aprendizaje<sup>15</sup> de reglas<sup>16</sup> gramaticales.

6

---

\*7

---

8

---

9

---

10

---

<sup>11</sup> teaching

\*<sup>12</sup> world

\*<sup>13</sup> greater

\*<sup>14</sup> less; lesser

<sup>15</sup> learning

<sup>16</sup> rules

La gente aprende español por una  
variedad de razones.<sup>17</sup> En California, por  
ejemplo, los policías y los empleados del  
gobierno lo estudian para poder tratarse mejor  
con gente de habla hispana. Muchas  
empresas<sup>18</sup> mercantiles<sup>19</sup> de los Estados  
Unidos contratan<sup>20</sup> a gente bilingüe,<sup>21</sup> es  
decir, que habla español e inglés. La  
casa<sup>22</sup> Sears Roebuck inició<sup>23</sup> recientemente  
programas para enseñarles español y francés  
a sus administradores y agentes<sup>24</sup> de  
compras que trabajan en el extranjero.<sup>25</sup>

- Este sistema no requiere<sup>26</sup> nada de  
conjugaciones<sup>27</sup> verbales,<sup>28</sup> ni largas  
listas de vocabulario<sup>29</sup> que aprender  
fuera<sup>30</sup> de contexto<sup>31</sup> - dijo un  
funcionario<sup>32</sup> de la conocida empresa  
norteamericana.

17 reasons

\*18 firms; enter-  
prises

19 commercial

20 hire

21

22 business firm

23 started

\*24

\*25 abroad; over-  
seas

26

27

28

29

30 out

31

32 official

Some of the numbered underlined words in the Narrative have English cognates (similar forms and meaning in English). These have not been translated for you, but numbered spaces have been provided in the margin. Go back to the NARRATIVE and guess at the meaning of each of the cognates. Write your guesses in the appropriate spaces in the margin, then check your answers with the Key.

Write answers in English to the following questions based on the Narrative.

1. What is this article about?

---

2. Why are increasing numbers of people studying Spanish?

---

3. How was the new teaching system developed?

---

4. What characterizes this system?

---

5. Why are the police and government employees studying Spanish?

---

6. What are many commercial firms doing?

---

7. Why has the Sears Roebuck Company become interested in offering Spanish courses?

---

8. What has been eliminated from the language program used at Sears?

---

Translate the following sentences into English.

1. ¿Leíste el artículo que escribió el diplomático argentino?

---

2. Hace dos meses que conocí a la muchacha brasileña.

---

3. José, no le des malos consejos a mi hermano menor.

---

4. Hace tres días que me siento muy cansado.

---

5. Para tratar a personas de diferentes países, es necesario saber su idioma.

---

6. No sabía si debía tratarlo de tú.

---

7. Ese señor vivió muchos años en el extranjero.

---

8. Sólo quiero saber si le escribiste al agente.

---

Translate the words and phrases in parentheses into Spanish.

1. \_\_\_\_\_, no quise ir \_\_\_\_\_.  
(Actually) (with you (fam.))
2. Casi siempre \_\_\_\_\_.  
(he used to address me in the familiar)
3. \_\_\_\_\_ tenemos dinero, salgamos.  
(Since)
4. \_\_\_\_\_ todos los documentos que quería.  
(You (fam.) didn't bring)
5. \_\_\_\_\_ terminar el proyecto antes del mes de  
(We should) diciembre.
6. Esa maestra siempre \_\_\_\_\_ los nuevos alumnos.  
(worries about)
7. ¿Encontró Ud. \_\_\_\_\_ buscaba?  
(everything (that))
8. La niña \_\_\_\_\_ al verme.  
(was frightened)
9. ¿ \_\_\_\_\_ te gusta más, éste o ése?  
(Which one)
10. \_\_\_\_\_ llega en dos días.  
(The fleet)



Translate the following sentences into Spanish.

1. Did you (fam.) really think we weren't going to do it?  
\_\_\_\_\_
2. Does he always address everyone in the familiar?  
\_\_\_\_\_
3. Her daughter is older than mine.  
\_\_\_\_\_
4. You (fam.) must return the books you found.  
\_\_\_\_\_
5. The one who told me left the party early.  
\_\_\_\_\_
6. Did you (fam.) tell everything you knew about the matter?  
\_\_\_\_\_
7. My brother lived in a Spanish-speaking country for four years.  
\_\_\_\_\_
8. He knew as much as I did about the problem.  
\_\_\_\_\_
9. Since she didn't want to help us, we left without her.  
\_\_\_\_\_
10. The mechanic charged me too much and he didn't do a good job.  
\_\_\_\_\_

Listen to the following words from the Narrative for this lesson. Each will be given twice; once in isolation and once in a complete sentence. Translate each of the sentences into English.

1. \_\_\_\_\_
2. \_\_\_\_\_
3. \_\_\_\_\_
4. \_\_\_\_\_
5. \_\_\_\_\_
6. \_\_\_\_\_
7. \_\_\_\_\_



WORKBOOK

KEY

LISTENING AND READING COMPREHENSION EXERCISES

MODULE 4



FRAME 1

- A. A key has not been provided for exercise A. Have your teacher check your answers.
- B. 1. ¿Cuál es su apellido? 2. ¿Cuál es la capital de su estado? 3. ¿Cuáles colores le gustan más? 4. ¿Cuál es su profesor, el alto o el bajo? 5. ¿Cuáles son los partes militares? 6. ¿Cuál fue la fecha del último examen? 7. ¿Cuál es su dirección? 8. ¿Cuál de los políticos es más rico? 9. ¿Cuáles son las horas de oficina en el Cuartel General? 10. ¿Cuál de sus familiares le gusta más?
- C. Which one of them does the admiral need? 2. At nine o'clock in the morning a corporal brought the reveille report. 3. The admiral sent the confidential report to all units. 4. There's a calendar on the desk. 5. The folder must be in the file. 6. Which are the soldiers who don't want to go to war? 7. Why did he put the reports in the drawer? 8. Which one of those girls do you like most? 9. Which of the reports deals with naval operations? 10. What we wanted to know was how many dead there were in the attack.
- D. I. 1(b) 2(c) II. 1(b) 2(b) III. 1(c) 2(c)  
IV. 1(a) 2(b)
- E. 1. Nosotros no tenemos que hablar de la revolución. (b)  
2. Ud. no debe poner las copias de los recibos con los originales. (c)  
3. ¿Por qué no trajo la guía de teléfonos? (c)  
4. ¿En cuál de las guerras participó su unidad? (b)  
5. La discusión fue acerca de la segunda guerra. (a)  
6. Le pagué al gobierno lo que le debía. (a)  
7. José anotó la información en el calendario. (b)  
8. Todavía no sabemos quién comenzó el ataque. (c)  
9. ¿En qué operación no participaron Uds.? (a)  
10. Tráigame otro bloc de papel, por favor. (c)
- F. 1. Return this folder to the secretary. 2. We could not attend the meeting. 3. I think the original is at headquarters. 4. I offered him (her) a receipt, but he (she) refused (didn't want) it. 5. Where did he put the telephone book? 6. They did not participate in the maneuvers because it was very cold. 7. They already repaired (fixed) the typewriter. 8. What you asked me for is not in the file. 9. We must pay him (her) what we owe him (her). 10. Who was the one who cleaned the desks?

FRAME 2

- A. 1(a) 2(c) 3(a) 4(d) 5(b) 6(a) 7(c) 8(a) 9(d)  
10(a)
- B. I. 1(c) 2(b) II. 1(c) 2(d) 3(c) III. 1(a) 2(c)  
3(c) IV. 1(b)
- C. 1. We must (ought to) (should) continue straight ahead along this road. 2. According to the schedule, I don't have anything to do until 10:30 a.m. 3. I thought (was under the impression) that it was necessary to begin earlier. 4. I already signed all the documents that you brought this morning. 5. I was there yesterday; however, I wasn't able to see them. 6. It was impossible to wash so many dishes in one hour. 7. The bomb destroyed the factory's elevator. 8. Not everyone agrees with the new Constitution. 9. Go and see if they need something (anything). 10. When he was in charge of the operations these things didn't (use to) happen.

FRAME 3

- A. 1. 15 2. 869 3. 35 4. 22,960 - 56 5. 38  
6. 3,500 7. 437 8. 533,600 9. 70,293 - 17,992  
10. 555,000
- B. 1. Dice que oyeron 15 explosiones.  
He says they heard 15 explosions.
2. Nuestra compañía construyó 869 kilómetros de caminos en Latinoamérica.  
Our company built 869 kilometers of roads in Latin America.
3. Los guerrilleros destruyeron 35 gasolineras en una semana.  
The guerrillas destroyed 35 gas stations in one week.
4. Leyó 22,960 palabras en 56 minutos.  
He read 22,960 words in 56 minutes.
5. No comprendo por qué Ud. incluye a esos 38 hombres en la operación.  
I don't understand why you include those 38 men in the operation.

## NARRATIVE

- A. 1. denounces 3. liberation 4. violations 5. regime  
6. governmental 7. provinces 9. bulletin 11. regi-  
ments 13. artillery 14. attacked 16. revolutionary  
18. combats 19. troops 20. caused 23. captured  
26. calibers 30. expansion 31. liberated 32. accused  
33. sector 38. strategic 43. bombarded 44. delegation  
46. commission 49. accused 51. activities 52. sub-  
versive.
- B. 1. Tuvieron lugar en las provincias centrales de San Julián  
y Victoria, y en la sureña de Trinidad.  
2. Participaron los Regimientos 42, 44, 45 y 53 de Rosario.  
3. El gobierno tuvo 80 bajas.  
4. Porque se resistieron a ser trasladados.  
5. Después de muertos.  
6. Capturaron 31 armas de diversos calibres.  
7. Exigió la libertad de cinco personas.  
8. Es el jefe del sector militar de Granada.  
9. Atacó las zonas que estaban bajo el control del Ejército  
Revolucionario.  
10. Señaló la muerte de 26 civiles en la provincia de  
Trinidad.

## REVIEW

- A. 1. Cuáles 2. El parte de diana 3. no debemos firmar  
4. Las que 5. ese ataque 6. no incluyó 7. el archi-  
vo 8. almirante 9. Esta máquina de escribir  
10. llevar a cabo.
- B. 1. ¿Cuál es su horario? 2. Ella creyó lo que le dije.  
3. Uds. no incluyeron en su informe una lista de las  
zonas que visitaron. 4. Él está a cargo de la Compañía A.  
5. No me pregunte por qué incluyo a ese hombre entre mis  
enemigos. 6. Él dice que no oyó la explosión. 7. El  
ingeniero que construyó el puente quiere más dinero.  
8. Ellos ya leyeron el informe sobre el nuevo presupuesto  
del gobierno. 9. Los guerrilleros destruyeron la represa  
anoche. 10. Antes era necesario estar aquí a las 7:30  
de la mañana; pero ahora no es necesario llegar a esa hora.

## VOCABULARY PRACTICE

1. The guerrilla bands, supported by our enemies, want to  
destroy our democracy. 2. Before the infantry attack, the  
artillery bombarded the enemy positions. 3. There were  
many dead and wounded among the troops.



4. My uncle participated in only one battle (combat) during the war. 5. That happened after the President's death. 6. These wounded have to be transferred immediately. 7. However (nevertheless) they carried out all their plans. 8. The engineer pointed out the new roads on the map. 9. Thank God my brother wasn't among the casualties! 10. Some zones (areas) of the south were occupied by the guerrillas.

FRAME 1

- A. 1. Ramon's car is as new as mine. 2. My neighbor knows how to fix cars as well as a mechanic. 3. We have less homework than the students of Chinese. 4. Maria Isabel was the prettiest girl at the party. 5. The people of Amerindia drank more wine than beer. 6. I studied as much as the others, but learned less than they (did). 7. The captain and I had to push it. 8. The mechanic didn't warn me that the carburetor was dirty. 9. To fix (when it comes to fixing) cars, the worst mechanic is better than I (am). 10. The best thing is (it is best) not to pay (any) attention to him.

- B. 1. 58 2. 50,113 3. 1,577 4. 891 5. 114 6. 4,623  
7. 36 8. 25,473 9. 212 10. 45 11. 13,499 12. 87  
13. 44 14. 7,610 15. 333

- C. 1. El examen de mañana es el más importante del curso. Tomorrow's exam is the most important one of the course.  
2. El taxi iba tan despacio como el tranvía. The taxi was going as slowly as the streetcar.  
3. Este año no hubo tantos accidentes como el año pasado. This year there weren't as many accidents as last year.  
4. El motor de arranque nos costó más de lo que esperábamos. The starter cost us more than we expected.  
5. El auto que acabo de comprar es mejor que el que tenía. The car (that) I just bought is better than the one I had.  
6. Ayer tuve que empujar mi auto porque el motor no arrancaba. Yesterday I had to push my car because the motor wouldn't start.  
7. Esos automóviles son buenos, pero son carísimos. Those cars are good, but they are very (extremely) expensive.  
8. Los caminos están peores que el invierno pasado. The roads are worse than last winter.  
9. Más de 20,000 personas asistieron al juego de fútbol. More than 20,000 persons attended the soccer game.  
10. El ladrón no le hizo caso al policía. The thief paid no attention to the policeman.

FRAME 2

A. 1(d) 2(b) 3(a) 4(d) 5(c) 6(a)

B. ¿Tiene Ud. algún problema con su auto? Llévelo al Taller Pérez. Nosotros nos especializamos en afinaciones electrónicas y transmisiones automáticas. Revisamos su vehículo antes y después de hacer cualquier trabajo. Recuerde Ud. el nombre Taller Pérez, donde garantizamos todos nuestros trabajos y repuestos.

nos especializamos - we specialize

afinaciones - tune-ups

electrónicas - electronic

C. a(2) b(3) c(4) d(5) e( ) f(1)  
g(6) h(9) i( ) j(10) k(8) l(7)

D. 1. As much as a large man. 2. A screwdriver. 3. Pliers; mechanics and others. 4. To tune a motor correctly. 5. The brakes are very bad. 6. The sparkplugs last a long time. 7. My watch; not as much as I thought.

E. 1. El motor de arranque de mi carro hace mucho ruido.  
My car's starter makes a lot of noise.  
2. La reparación del radiador me costó tanto como uno nuevo.  
The repair of the radiator cost me as much as a new one.  
3. ¿Cuánto me cobra por reparar el carburador?  
How much will you charge me to repair the carburetor?  
4. Algunas de las herramientas que el mecánico usa son carísimas.  
Some of the tools that the mechanic uses are extremely expensive.  
5. Ése es el mejor taller de la ciudad.  
That's the best shop in town.  
6. Es importante saber afinar bien el motor de un automóvil.  
It's important to know how to tune an automobile's engine well.  
7. Muchos vehículos tienen frenos de aire.  
Many vehicles have air brakes.  
8. Generalmente, ponen bujías nuevas cuando afinan el motor de un auto.  
Generally, they put in new spark plugs when they tune a car's motor.  
9. Mucha gente tiene destornilladores y pinzas entre las herramientas que tiene en casa.  
Many people have screwdrivers and pliers among the tools they have in their house.

- F. 1. 676 2. 1984 3. 8,126 4. 900 5. 42,099  
 6. 1,485 7. 236 8. 61,472 9. 9,174 10. 34,932  
 11. 2,000 12. 388 13. 53,998 14. 3,000  
 15. 30,247

FRAME 3

- A. 1(b) 2(d) 3(c) 4(c) 5(a) 6(d)
- B. 1. ¿Quién va a cambiarme el aceite?  
 Who is going to change the oil for me?
2. El general se preocupaba porque había muchos soldados enemigos cerca de la frontera.  
 The general worried because there were many enemy soldiers near the border.
3. Para calentarlo es necesario prenderlo unos minutos ante de salir.  
 To warm it (up) it's necessary to turn it on for a few minutes before leaving.
4. Ella se preocupaba diariamente por las cosas que los otros dejaban sin hacer.  
 She worried daily about the things (that) the others left undone.
5. Generalmente, el que compra un coche usado tiene muchos problemas.  
 Generally, he who buys a used car has many problems.
6. El mecánico que afina los motores no trabaja los fines de semana.  
 The mechanic who tunes the engines doesn't work week-ends.

NARRATIVE

- A. 1(c) 2(b) 3(d) 4(b) 5(a) 6(d) 7(a) 8(d)
- B. A key has not been provided for this exercise. Have your teacher check your narration.

REVIEW

- A. 1. ¿Qué es necesario hacer para cambiar una llanta desinflada? 2. Es importante usar el espejo retrovisor cuando Ud. maneja su auto. 3. El chofer de un auto de cambios tiene que usar tres pedales para manejarlo. 4. El limpiaparabrisas nos permite (deja) ver la carretera (el camino) cuando llueve. 5. Para funcionar bien, el carburador necesita gasolina, y aire completamente limpio. 6. Cuando viajamos en auto ponemos nuestras maletas en el baúl. 7. Dos de las herramientas más importantes para las reparaciones de autos son el destornillador y la llave.
- B. a ( ) b ( ) c(1) d ( ) e(4) f(5) g(2) h(6) i(3) j(7)

## VOCABULARY PRACTICE

1. I need a bigger rearview mirror.
2. The mechanic used a small wrench to repair the carburetor.
3. The muffler was broken and made a lot of noise.
4. I always carry a spare fan belt.
5. Be so kind as to clean the windshield for me.
6. There's a speck of dirt in the gas pump.
7. Careful! The truck has air brakes.
8. That shop refused to guarantee the shocks I bought.
9. Put the spare tire in the trunk, please.
10. English cars have the steering wheel on the right-hand side.
11. I put the luggage in the rear seat.
12. Three people can sit in the front seat.
13. What bad luck! The windshield wiper doesn't work.
14. His car's stick shift is to the right of the steering wheel.

## FRAME 1

- A. 1(b) 2(d) 3(a) 4(c) 5(c) 6(b) 7(a) 8(c) 9(d)  
10(a)
- B. 1. Fernando, tú te preocupas demasiado.  
Fernando, you worry too much.  
2. Nos falta mucho para llegar.  
We have a long way to go.  
3. No, a mí no me falta nada.  
No, I'm not missing anything.  
4. Estás peor que antes.  
You're worse than before.  
5. Cóbrale quince dólares por hora.  
Charge him (her) \$15 dollars an hour.  
6. Toca a la puerta.  
Knock at the door.  
7. Al capitán le falta poco para ser mayor.  
The captain is about to become a major.  
8. Tienes que ir despacio; hay mucho tráfico.  
You have to go slow; there's a lot of traffic.
- C. 1. 250 2. 41 3. 3,900 4. 55,650 5. 44,298  
6. 2,800 7. 49,134 8. 36 9. 64,000 10. 271

## FRAME 2

- A. 1(c) 2(d) 3(b) 4(b) 5(a) 6(a) 7(c) 8(b)
- B. 1. Pepito, párate para saludar a la señora.  
Pepito, stand up to greet the lady.  
2. Sus padres se pusieron muy contentos cuando lo vieron llegar.  
His parents got (became) very happy when they saw him arrive.  
3. Ellos nunca se equivocan.  
They never make a mistake.  
4. ¿Ya se fue el capitán para Centroamérica?  
Did the captain already leave for Central America?  
5. ¿Te pones muy nerviosa cuando vas al dentista?  
Do you get very nervous when you go to the dentist?  
6. No hagan tanto ruido, porque se asusta el niño.  
Don't make so much noise, because the little child gets scared.  
7. No los llamé, porque no quería molestarlos.  
I didn't call them (you), because I didn't want to bother them (you).  
8. ¡Qué linda se ve María con ese vestido!  
How pretty Maria looks with that dress!

9. Esa señora se queja de todo.  
That lady complains about everything.
10. Si comes demasiado, te vas a enfermar.  
If you eat too much, you are going to get sick.

C. a(4) b( ) c(1) d(5) e(3) f(2)  
g(6) h(9) i(10) j(7) k( ) l(8)

FRAME 3

A. 1(b) 2(c) 3(a) 4(b) 5(c) 6(a) 7(d) 8(b) 9(a)  
10(d)

B. (1) Cuernavaca, México. Siete personas murieron y una niña resultó gravemente herida, cuando un auto, que iba a exceso de velocidad, se estrelló contra un camión.

murieron - (they) died

resultó - turned out (to be); was (as a result); wound up

gravemente - gravely

exceso de velocidad - speeding; excessive speed

(2) Un camión de carga patinó y cayó en un barranco de 80 metros de profundidad. El vehículo se destrozó contra las rocas y sólo quedaron partes del motor y del chasis.

carga - cargo

profundidad - depth

cayó - fell

se destrozó - was destroyed; demolished

barranco - gully, gorge

chasis - chassis

metros - meters

(3) San Andrés, 4 de noviembre. El Departamento de Tránsito le recuerda que es ilegal manejar después de la fecha de vencimiento de su licencia. No se olvide de renovarla.

recuerda - reminds

ilegal - illegal

vencimiento - expiration

renovarla - to renew it

- C. 1. 19,103 2. 33,612 3. 1,407 4. 21,852 5. 18,931  
6. 4,115 7. 42,300 8. 2,004 9. 58,999 10. 8,135

#### NARRATIVE

- A. 2. congestion 3. accelerated 4. increment, increase  
6. paralyze 9. reduce 10. maximum 12. to circulate;  
to move 14. enormous; huge 16. certain 17. coordinator  
18. exist 19. symptoms 20. fatal 24. demon; devil  
25. urban 34. transport 35. million 36. contribute  
38. to resolve; to solve 40. form 43. authorities  
44. accuse 47. emergency 49. prohibited; forbidden.

- B. 1. Traffic congestion in Rio de Janeiro 2. 15 kilometers  
per hour 3. Daily 4. That within one year the vehicles  
will not be able to circulate (move). 5. He is the Traf-  
fic Coordinator of Guanabara. 6. The drivers of private  
vehicles 7. The urban devil 8. 100 9. The Metro (sub-  
way) 10. Almost a million and a half. 11. 12,000 per  
hour 12. Motorists stop to make flirtatious remarks to  
the girls and to make emergency purchases.

#### REVIEW

- A. 1. He (she) got scared when he saw the line of motorists who  
were going downtown. 2. Do you get nervous when a police-  
man stops you to give you a fine (ticket)? 3. In this  
state there are more than ten million owners of private  
cars. 4. Juan is lacking (has no) energy because he got  
sick last month. 5. This morning I made a mistake; I had  
to go to the auditorium but I stayed in here. 6. Ella  
se quejó de que el regalo era algo pequeño y de que lo  
recibió demasiado tarde. 7. Vístete, o vamos a llegar  
tarde (nos vamos a tardar). 8. No se olvide de tocar  
(a la puerta). 9. Él maneja un automóvil (auto, coche,  
carro) particular. 10. Un candidato faltó, y dos no  
llegaron a tiempo.
- B. 1. olvídate de 2. dos millones 3. debido a las  
multas 4. Se puso muy contento 5. llámame  
6. Levántate 7. compras 8. amenazó 9. casas par-  
ticulares 10. me preocupo 11. advirtieron 12. te  
equivocas 13. Nos faltan 14. lo asusté (a él) - se  
asustó 15. el dueño 16. Párate 17. me enfermo  
18. importa 19. Nos falta poco 20. hay que; es  
necesario



## VOCABULARY PRACTICE

1. He says they threatened him, but that he didn't get scared.
2. Private homes are (now) very expensive.
3. There was a line three blocks long to buy gas.
4. He refused to pay the fine (ticket), and they detained (held) him.
5. There was no game due to the bad weather.
6. The Arce sisters are the owners of the (department) store.
7. Are you going downtown this afternoon?
8. There are too many motorists (drivers) that don't pay attention to the laws.
9. His (her) uncle lost more than three million pesos in that business.
10. I forgot to make the purchases you (he, she) asked me to.

FRAME 1

- A. 1. No me esperes, porque voy a llegar tarde.  
Don't wait (up) for me, because I'm going to be (arrive) late.
2. No les des todo el dinero.  
Don't give them all the money.
3. Léenos la carta, por favor.  
Read us the letter, please.
4. Carlitos, no te sientes en la mesa.  
Carlitos, don't sit on the table.
5. No pierdas la información que te dieron.  
Don't lose the information (that they gave you).
6. No pidas más tragos; estás mareado.  
Don't order any more drinks; you're dizzy.
7. No apagues la luz.  
Don't turn off the light.
8. No te preocupes, yo lo arreglo.  
Don't worry, I'll fix it.
9. No lo empujes hacia acá.  
Don't push it this way (towards here).
10. No lo creas.  
Don't believe it.
11. No llegues tarde.  
Don't arrive (be) late.
12. No destruyas en un día el trabajo de todo un año.  
Don't destroy in one day the work of a whole (an entire) year.
13. No te quedes ahí, muchacho; pasa.  
Don't stay there, boy; come in.
14. Si estás borracho, no manejes.  
If you're drunk, don't drive.
15. No pongas la lámpara en ese rincón.  
Don't put the lamp in that corner.
- B. I. 1(b) 2(c) 3(b) II. 1(a) 2(b) 3(d) III. 1(d)  
2(b) 3(a)

FRAME 2

- A. 1(c) 2(d) 3(a) 4(b) 5(d)
- B. I. 1(b) 2(c)

espacial - space

astronautas - astronauts

observaron - observed

territorio - territory

detectar - detecting

fuentes - sources

geotérmica - geothermic; geothermal

II. 1(b) 2(d) 3(c)

asesor - adviser

presidencial - presidential

internos - internal

aumento - increase

racionamiento - rationing

combustibles - fuels

congreso - congress

autorizar - authorize

propuesta - proposal

C. 1. 17 2. 13 3. 111 4. 150 5. 284 6. 230  
7. 1,832 8. 370 9. 28 10. 3,550

FRAME 3

- A. 1. ¡Qué simpática es tu prima, Luis!  
How nice your cousin is, Luis!  
2. ¿No viajabas mucho en aquel tiempo?  
Didn't you travel much at that time?  
3. Ése no es el periódico de hoy, es el de ayer.  
That's not today's paper; it is yesterday's.  
4. ¿Sabías tú que él era del Paraguay?  
Did you know that he was from Paraguay?  
5. Tú terminabas de trabajar temprano.  
You used to finish working early.  
6. ¡Qué mala suerte tuvimos!  
What bad luck we had!  
7. Ya vendieron la casa de al lado.  
They already sold the house next door.  
8. ¡Qué gorda se puso Juanita!  
How fat Juanita has become!  
9. El de la izquierda me gusta más.  
I like the one on the left better.  
10. No trabajes hasta muy tarde.  
Don't work too late.

B. I. 1(c) 2(b) 3(b) 4(d) 5(a)

tendrá lugar - will take place relacionados - related

congreso - congress

futuro - future

olímpico - olympic

actividad - activity

deporte - sport(s)

tópico - topic

temas - themes

delegación - delegation

cubana - Cuban

profesionalismo - profession-  
alism

amateurismo - amateurism

II. 1(d) 2(b)

autoridades - authorities

brote - outbreak

cólera - cholera

aislado - isolated

enfermedades - diseases

contagiosas - contagious

no tiene relación con - is unrelated to

III. 1(a) 2(c)

aunque - although

estadounidenses - U.S. in-  
habitants

población - population

mundial - world

consumir - consume

se produce - is produced

petróleo - petroleum; oil

extraído - extracted

en medio de - in the middle of

#### NARRATIVE A

A. 1. social 2. group 7. personalities 8. circle  
9. society 14. coordinate 18. delicious

B. 1. Ayer por la noche, ofrecieron una comida a un grupo de sus amistades.  
2. Asistieron conocidas personalidades del círculo militar.  
3. Los padres de Conchita se encontraban entre los invitados.  
4. Van a coordinar los planes iniciales de la Operación Unidad.  
5. (Al aire libre,) en los jardines de la (hermosa) residencia.

#### NARRATIVE B

A. 1. cocktail 4. clients; customers 5. reverend  
9. repeated 10. occasions 12. champagne 13. association.

B. 1(c) 2(b) 3(a) 4(d)

## REVIEW

- A. 1. me decías 2. digas 3. no se vaya 4. la del  
5. Qué lindos (bonitos, hermosos) 6. lo de 7. simpático  
8. bien parecido 9. No me esperes 10. No vuelvas  
(regreses)

## VOCABULARY PRACTICE

1. There was a group of friends present there.
2. The party was on the occasion of (for) his promotion.
3. They are going to study the social problems of the Canal Zone.
4. There were many guests.
5. They served tasty dishes as well as delicious beverages.
6. How beautiful the house is!
7. Our clients (customers) never complain about what we sell to them.
8. For me, a good cheese is the best dessert.
9. His (your) mission is to coordinate all the plans.

## FRAME 1

- A. 1(b) 2(c) 3(a) 4(d) 5(a) 6(c) 7(d) 8(c) 9(a)  
10(b)
- B. 1. Había un desvío en la carretera.  
There was a detour in the highway.
2. El mapa hidrográfico tiene ríos, lagos, y mares.  
The hydrographic map has (shows) rivers, lakes, and seas.
3. Los mapas topográficos tienen las montañas de la región.  
The topographic maps have (show) the mountains of the region.
4. Tienen buenas carreteras de primer orden y algunos caminos de tierra.  
They have good main highways and some dirt roads.
5. Cuando llueve es muy peligroso manejar si el camino no está pavimentado.  
When it rains it is very dangerous to drive if the road isn't paved.
6. Él manejó con cuidado porque los niños iban con él.  
He drove carefully because the children were (going) with him.
7. En un día claro es posible ver la costa desde el barco.  
On a clear day it is possible to see the coast from the ship.
8. Cerca de mi casa hay un laguito.  
There is a small lake close to (near) my house.
9. En esa ciudad todas las calles están pavimentadas.  
In that city all the streets are paved.
10. No siga por esta calle porque hay un desvío.  
Don't follow (stay on) this street because there's a detour.
- C. 1. 957 2. 13,240 3. 2,780 4. 7,802 5. 11,001  
6. 1,973 7. 1,492 8. 35,575 9. 15,907 10. 6,760

## FRAME 2

- A. 1. Le faltan los mapas. 2. Tiene que ir después de la una. 3. Va a recoger los que le faltan. 4. Él pregunta cómo puede conseguirlos. 5. Va a ir a la oficina geodésica. 6. Va a ir (a verlo). 7. Necesitan llevar agua y gasolina. 8. Consiguió un buen trabajo. 9. Necesitaba hacer una llamada por teléfono. 10. No lo quiere porque no le sirve.

B. 1. El Director del Instituto Nacional de Asuntos Indígenas declaró que los indios, en nuestros días, se hallan casi totalmente aislados del desarrollo general del país.

indígenas - Indian

totalmente - totally

indios - Indians

aislados - isolated

se hallan - are; find them- selves

desarrollo - development

2. El Gran Canal del Desagüe del Valle de México constituye un grave riesgo para la salud de las poblaciones por las que pasa, dijo ayer el ministro.

desagüe - drainage; sewage

grave - grave; serious

valle - valley

riesgo - risk

constituye - constitutes

3. El canciller explicó que los países latinoamericanos no deben esperar que en una sola reunión con Kissinger puedan resolver problemas de siglos.

canciller - chancellor

siglos - centuries

resolver - solve

4. Hoy, en carta abierta al Presidente, la Asociación de Agricultores y Ganaderos dice que la nueva política de precios flexibles es un hecho de enorme importancia.

abierta - open

precios - prices

asociación - association

flexibles - flexible

agricultores - farmers

hecho - fact

ganaderos - cattle breeders

enorme - enormous

política - policy

5. Alumnos de la Escuela Tecnológica del puerto de San Ramón participan en un programa de cultivo de ostras, y creen que en un año esa zona costera va a poder abastecer toda la región.

tecnológica - technological

costera - coastal

cultivo - cultivation

abastecer - to supply

ostras - oysters

C. 1(b) 2(a) 3(d) 4(c) 5(b) 6(a) 7(d) 8(d) 9(c) 10(b)

FRAME 3

A. A key has not been provided for Exercise A. Have your teacher check your answers.

1. ¿Se preocupa mucho Ud. por el precio de la gasolina?
2. ¿Qué le dijo Villa al mayor sobre la reunión?
3. ¿Se puso Ud. nervioso antes de tomar el último examen?
4. ¿Está su trabajo al día? 5. ¿Se olvidó de traer las cintas esta mañana? 6. ¿Se molesta Ud. mucho cuando le dan una multa? 7. ¿A qué hora se fue Ud. de la escuela ayer?

B. 1. Give me the one (that is) in that corner. 2. They were talking with a drink in their hands. 3. By the way, don't forget the meeting! 4. He got very sick. 5. They put on their uniforms. 6. Don Miguel, don't sit (formal) there. 7. Miguel, don't sit (familiar) in that chair. 8. You look very well with that tie. 9. I'm sorry, but I ran out of cigarettes. 10. The pictures were very beautiful. 11. The candidate saw himself on television. 12. They forgot to let me know. 13. He's not going to worry about the bill. 14. They were frightened to see how expensive things were.

NARRATIVE

A. 1. Hay pantanos, selvas tropicales, desiertos, llanuras, montañas, dunas, etc. 2. Al suroeste de Vicente. 3. En la Zona Noreste. 4. Hay una autopista y un ferrocarril. 5. Hay un ferrocarril, un camino pavimentado, una carretera, una selva tropical, un puente y un pantano. 6. Hay un camino de tierra. 7. Uno ve llanuras, ríos, un lago y montañas. 8. Se encuentran en el río Salado. 9. Hay una planta hidroeléctrica. 10. Quieren decir que hay cuevas. 11. Vicente y San Pablo. 12. Construyeron un acueducto. 13. Lo traen en oleoductos desde los campos petrolíferos cerca de Paraíso (en la Zona Sureste). 14. En Lagunas, en Embarcadero, y frente a las refinerías de la Zona Federal. 15. Usan cables de alta tensión. 16. En el Golfo de Santa Catalina. 17. Selvas tropicales, montañas y pantanos. 18. Un canal y un río. 19. La que está en Ranchería. 20. Queda en la Zona Sureste.

REVIEW

A. 1. Ve 2. topográficos 3. faltan 4. Consiguí 5. se olvidó de 6. pantanos 7. se preocupa 8. pon 9. carpeta 10. A propósito 11. una represa 12. la bahía 13. Geodésico 14. dile 15. la autopista 16. el lago 17. población 18. un desvío 19. ten la bondad 20. comes 21. al mar 22. al día 23. la costa 24. pavimentadas 25. el campo 26. cabo - golfo



- B. 1. ¿Qué documento piden en la oficina de inmigración? - Piden el pasaporte. 2. Después de comer, ¿qué le pides al camarero? - Le pido la cuenta. 3. Si un policía lo detiene en la autopista, ¿qué le pide a Ud. primero? - Me pide la licencia de manejar. 4. ¿Le piden Uds. permiso al profesor antes de salir de la clase? - Sí, le pedimos permiso. 5. ¿A quién eligen en los EE. UU. cada cuatro años? - Eligen al presidente. 6. ¿Cuántos años sirve un recluta en la Fuerza Aérea? - Sirve tres o cuatro años. 7. ¿Sirve Ud. la cena en el comedor de las barracas? - Sí (No), yo (no) sirvo la cena en el comedor de las barracas. 8. ¿Para qué sirven los portafolios? - Sirven para poner documentos.

#### VOCABULARY PRACTICE

1. In this country, the tropical jungles (forests) are to the north.
2. They say that near the piers (wharfs, docks) they killed a woman.
3. They are going to build a landing field (strip) three miles from here.
4. They found petroleum (oil) in the swamps of Paraiso.
5. From the plane we could see the islands of the canal (channel).
6. The ship arrived at the bay this morning.
7. The prices of the flights of some air lines went up.

## FRAME 1

- A. A key has not been provided for Exercise A. Have your teacher check your answers.
- B.
1. Mi padre es de origen alemán.  
My father is of German origin.
  2. Hace casi veinte años que conozco a Manuel.  
I have known Manuel for almost 20 years.
  3. Hace sólo un mes que hablé con él.  
I spoke with him only a month ago.
  4. Hacía mucho frío el día que llegué a Nueva York.  
It was very cold the day I arrived in New York.
  5. Ese caballero es una persona muy conocida en este instituto.  
That gentleman is a very well-known person in this institute.
  6. Nadie me hizo caso cuando les pedí auxilio.  
No one paid any attention to me when I asked them for help.
  7. Según el médico, lo que más me hace falta es dormir ocho horas diarias.  
According to the doctor, what I need most is to sleep eight hours.
  8. Fue el asunto más discutido en la capital.  
It was the most discussed (talked about) matter in the capital.
- C.
- |    |       |    |        |    |        |     |        |    |        |    |       |
|----|-------|----|--------|----|--------|-----|--------|----|--------|----|-------|
| 1. | 35    | 2. | 3,123  | 3. | 793    | 4.  | 68     | 5. | 22,344 | 6. | 1,500 |
| 7. | 3,761 | 8. | 78,193 | 9. | 98,692 | 10. | 13,761 |    |        |    |       |

## FRAME 2

- A. 1(d) 2(a) 3(b) 4(b) 5(c) 6(c) 7(d)
- B.
1. En realidad, no supe qué decir cuando me llamaste.  
Actually, I didn't know what to say when you called me.
  2. ¿Por qué no viniste a la biblioteca antes de mediodía?  
Why didn't you come to the library before noon?
  3. Ya que trajiste la grabadora, toca la nueva cinta.  
Since you brought the tape recorder, play the new tape.
  4. Cuando el ladrón entró en la casa, ellos dormían.  
When the thief entered the house, they were sleeping.
  5. Yo no me sentía muy cómodo porque todo el mundo me trataba de tú.  
I didn't feel very comfortable because everyone was addressing me in the familiar.

6. ¿Por qué no me diste los mapas topográficos que necesitamos para la operación?  
Why didn't you give me the topographic maps that we need for the operation?
7. El avión despegó muy tarde en la noche.  
The plane took off very late at night.
- C. 1. Did you bring the passport? 2. Address me in the familiar, (man)! 3. Did you see your older brother?  
4. I'm very sorry. 5. I don't care at all (Nothing matters to me.) 6. We are almost there. 7. I'm against the revolution. 8. You got a little dizzy.

### FRAME 3

- A. 1. Deben asistir a la reunión. 2. Porque no tenía dinero. 3. Falta poco. 4. Hay que empujar el coche. 5. Es muy competente. 6. El (destornillador) de Raúl. 7. Todo lo que quería. 8. Llevó a cabo el proyecto social.
- B. 1. ¿Cuál de los cuadernos quiere Ud.?  
Which of the notebooks do you want?
2. ¡Esta comida está sabrosísima!  
This meal is (really) delicious!
3. Tu marido llegó al hospital tan pronto como pudo.  
Your husband arrived at the hospital as soon as he could.
4. ¿Es difícil aprender a manejar un auto de cambios?  
Is it difficult to learn to drive a manual shift car?
5. Vas a tener que aydarle con la gramática.  
You are going to have to help him(her) with grammar.
6. Escribe todos los ejercicios cuidadosamente.  
Write all of the exercises carefully.
7. Él se puso muy contento cuando la vio contigo.  
He became very happy when he saw her with you.
8. Todo el mundo se trata de tú en esta escuela.  
Everyone addresses each other in the familiar in this school.

### NARRATIVE

- A. 2. to communicate 4. use 6. utilize 7. system  
8. based 9. formulated 10. linguists  
21. bilingual 24. agents 26. require(s)  
27. conjugations 28. verbal 29. vocabulary  
31. context

- B. 1. Spanish instruction in the U.S. 2. Because of the need to communicate with a growing Spanish-speaking population, and because of its usefulness in travel or business. 3. By a group of well-known linguists in charge of language teaching to the military during World War II. 4. It places greater importance on the spoken language and less on learning grammar rules. 5. To deal better with Spanish-speaking people. 6. They are hiring employees bilingual in English and Spanish. 7. Because many of its administrators and buyers work abroad. 8. Verb conjugations and the learning of long vocabulary lists.

#### REVIEW

- A. 1. Did you read the article that the Argentinian diplomat wrote? 2. Two months ago I met the Brazilian girl. 3. Jose, don't give my younger brother bad advice. 4. I've been feeling very tired for three days. 5. In order to deal with persons from different countries, it is necessary to know their language. 6. I didn't know if (whether) I should address him in the familiar. 7. That man lived abroad for many years. 8. I only want to know if you wrote (to) the agent.
- B. 1. En realidad; contigo 2. me trataba de tú 3. Ya que 4. No trajiste 5. Debemos 6. se preocupa por 7. todo lo que 8. se asustó 9.Cuál 10. La flota
- C. 1. ¿Creíste en realidad que no íbamos a hacerlo? 2. ¿Siempre trata de tú a todo el mundo? 3. Su hija es mayor que la mía. 4. Debes devolver los libros que encontraste. 5. El que me lo dijo salió temprano de la fiesta. 6. ¿Dijiste todo lo que sabías sobre el asunto? 7. Mi hermano vivió (por) cuatro años en un país de habla española. 8. Él sabía tanto como yo sobre el problema. 9. Ya que no quería ayudarnos, nos fuimos sin ella. 10. El mecánico me cobró demasiado y no hizo un buen trabajo.

#### VOCABULARY PRACTICE

1. The manager of the firm refused (didn't want) to come. 2. His experience abroad helped him a lot (was very useful to him). 3. That is the river of greatest importance in the zone. 4. The world price of oil went up again. 5. The clients complained about the travel agent. 6. My aunt gets annoyed at the slightest things. 7. The engineers tried to use a new system to heat the water.

